

380GW

User Manual



Table of Contents

TABLE OF CONTENTS	02
INTRODUCTION TO YOUR DASH CAM	03
USING CCTV IN A COMMERCIAL ENVIRONMENT	04
PRECAUTIONS / CAUTIONS ON USING THIS PRODUCT	05
FCC INFORMATION	06 - 07
PRODUCT SPECIFICATION	08
PACKAGE CONTENTS / PRODUCT FEATURES	09
PARTS & CONTROLS	10 - 16
IN VEHICLE INSTALLATION	17 - 21
CONNECTING YOUR DASH CAM TO CAM VIEWER APP	22 - 23
POSITIONING YOUR DASH CAM	24
ANTI-TAMPER SECURITY INSTALLATION	25
CAM VIEWER APP	26 - 32
NEXTBASE SD CARDS	33
PC CONNECTION	34
TROUBLESHOOTING	35 - 36
CE MARK INFORMATION / SOFTWARE LICENSE AGREEMENT	37
WARRANTY / ONLINE & INTERNATIONAL PURCHASES	38
MORE NEXTBASE PRODUCTS	39
DASH CAM FUNCTIONS	40

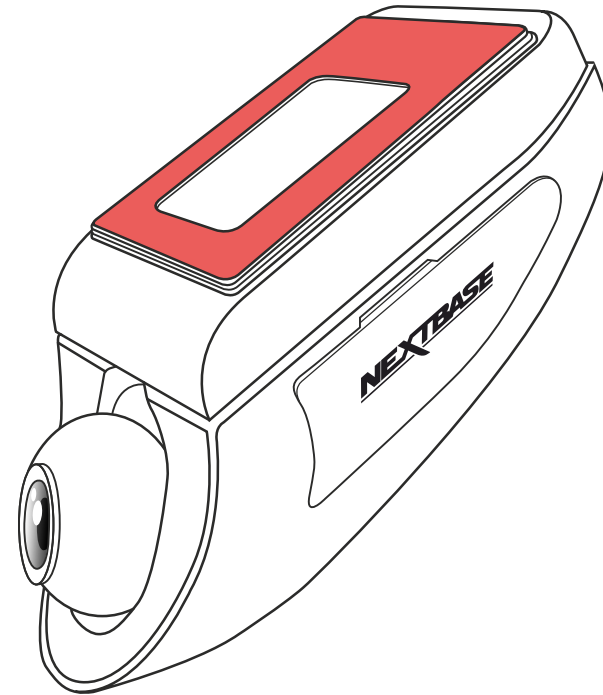

Introduction to your Dash Cam

The Nextbase range of Dash Cams have been designed specifically with ease of use in mind, it is recommended NOT to change the default settings, which have been carefully selected to give the best performance for day to day use.

Basic operation

The Dash Cam is set to record video, in files 1 minute in length. This means that each video file is a manageable size should you need to download and send to your insurance company. Eventually your MicroSD card will fill up with video files but don't worry, the camera automatically deletes the oldest file to make space for new recordings. This way you never run out of space and have plenty of driving historical evidence saved.

Typically a 16Gb card will store the last 2 hours of driving footage.

The Time and Date are automatically set upon the camera from satellite data. They will also update automatically for Daylight Savings Time, again based on the Country selected.

Automatic Start / Stop Technology.

The Dash Cam senses power supplied to the cigarette lighter socket as soon as the vehicle ignition is turned on and will start to record automatically.

When the ignition is turned off, the Dash Cam will perform an automatic shutdown process.

1. Tips for capturing best video footage:

- 1.1 Position the Dash Cam in the centre of the windscreen and ideally behind the rear view mirror so it is not an obstruction to the driver's field of view.
- 1.2 Reduce the amount of sky in the picture, by angling the view of the camera towards the road. Too much sky will make the road appear darker due to the automatic exposure compensation.
- 1.3 Remove unnecessary items from your dashboard. If objects are placed on your dashboard these can cause reflections to be seen on the windscreen and these reflections may be captured during recording.

2. Tips for stable memory card performance:

- 2.1 Periodically format the memory card. Every 2-3 weeks we recommend that you reformat the memory card. This will wipe any files from the card and set it up afresh for continued use with your Dash Cam.
Of course, you should only do this AFTER you've downloaded any files from the card that you may want to keep, as formatting the card will remove all content.
- 2.1 Format your memory card using the Dash Cam, this will make sure that the card is structured specifically for your camera.
- 2.2 Switch off the Dash Cam before removing or inserting the SD memory card, to prevent the chance of damage being caused to the memory card or the files stored upon it.

Using CCTV in a Commercial Environment

The 380GW can be used in a private vehicle or in a commercial environment. If being used in a commercial environment certain standards must be adhered to.

When using the Nextbase 380GW in a commercial vehicle you must ensure that you comply with any applicable legislation set out by the Government in your location. The following guide is written for usage of the product in the UK.

UK requirements include but are not limited to the Data Protection Act, the CCTV Code of Practice and the Surveillance Camera Code of Practice.

A simple CCTV Compliance Checklist is included upon the Software Disk included with the Nextbase 380GW. Additional supporting documents are also included to help Data Controllers comply with applicable legislation. Example Policy and Procedure documents are also supplied (in editable Word document format) so that you can amend them to suit your business.

CCTV Compliance Checklist Steps

1. The CCTV Code of Practice states that there should be a pressing need for a camera to be installed in your vehicle as using cameras can be privacy intrusive. You should ensure that you have identified a clear need for a camera to be installed (e.g. For the purpose of driver and passenger safety)
2. You must have a designated Data Controller who will be responsible for ensuring data is recorded correctly and securely as well as ensuring all Operators are aware of all relevant policies and procedures regarding the use of Dash Cams. The Data Controller must register with the Information Commissioner's Office (ICO). This can be done by visiting www.ico.org.uk.

Data controllers will usually be organisations, but can be individuals, for example self-employed consultants. Even if an individual is given responsibility for data protection in an organisation, they will be acting on behalf of the organisation, which will be the data controller.
3. The CCTV Code of practice states that you must let people know when they are in an area where a surveillance system is in operation.

Supplied with your product are three 'CCTV Window Stickers' (shown below) for this purpose.

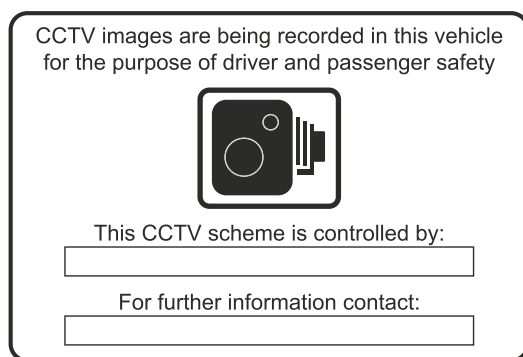

To comply with Surveillance Camera Legislation, the above window stickers should be located on all entrance points to your vehicle.

4. Using a suitable permanent marker pen please add contact details for CCTV / Data controller, before applying stickers to your vehicles windows
5. The Data Controller is responsible for ensuring that all Dash Cam operators/drivers are aware of their responsibilities regarding the data being recorded. Included in the "Nextbase Policy and Procedure Examples" Folder on the Software Disk is an Operator/Driver Briefing Checklist, to help the Data Controller monitor this.
6. The company should have clear, documented policies regarding all aspects of data being recorded and stored. These are covered individually later in the checklist. An example of a CCTV Recording Policy is included in the "Nextbase Policy and Procedure Examples" Folder on the Software Disk.
7. All Operators/Drivers should know where to find company policies and procedures for using the Dash Cam. This is covered in the Operator/Driver Briefing Checklist.
8. The Data Controller must state how long data is to be stored by the company. The CCTV Code of Practice states that data should be deleted once it is no longer needed. An example of a CCTV Data Storage Policy is included in the "Nextbase Policy and Procedure Examples" Folder on the Software Disk.
9. The Data Controller should specify how data is deleted once it is no longer needed. This is also covered in the CCTV Data Storage Policy example, on the Software Disk.
10. The Data Controller should decide who has access to stored data. This is also covered in the CCTV Data Storage Policy example on the Software Disk.
11. The Data Controller should decide how the company handles a request for access to data it has stored. An example of a CCTV Request for Access Policy is included in the "Nextbase Policy and Procedure Examples" Folder on the Software Disk.

Requests for Access can be made by members of the public or from Police forces.

Examples of both Public and Police request forms have been included in the "Nextbase Policy and Procedure Examples" Folder on the Software Disk.

CCTV Compliance Checklist and Example Documents produced using information provided by The Home Office, Information Commissioner's Office and the Surveillance Camera Commissioner. Contains public sector information licensed under the Open Government Licence v3.0.

The 380GW can be used in a private vehicle or in a commercial environment. If being used in a commercial environment certain standards must be adhered to.



Precautions

Please read this manual carefully before operation and keep it for future reference. It will be helpful should you encounter any operational problem.

WARNING: Do not expose this product to rain, moisture or water under any circumstances, doing so may result in the risk of electric shock or fire.

CAUTION: To reduce the risk of electric shock, do not perform any servicing other than that contained in the instruction manual unless you are qualified to do so.
Have the unit serviced by a qualified service technician if;
The Unit has been exposed to rain or water.
The unit does not seem to operate normally.
The unit exhibits a marked change in performance.

CHOKING HAZARD: Some Products may contain components that are small enough to be swallowed. Please keep out of reach of children.

WEEE: Disposal of Waste Electrical and Electronic Equipment and/or Battery by users in private households in the European Union.
 This symbol on the product or on the packaging indicates that this cannot be disposed of as household waste. You must dispose of your waste equipment and/or battery by handing it over to the applicable take-back scheme for the recycling of electronic equipment and/or batteries. For more information please contact your local household waste disposal office.

Cautions on using this product

1. Ensure that the windscreen/rear window is free of dirt or grease before placing mount upon it.
2. Do not obscure the view of the road ahead or impede the deployment of any airbags in the event of an accident.
3. When not in use, please disconnect the car adaptor from both the 12/24Vdc outlet in your vehicle.
4. Only clean the device with a soft dry cloth, for tough dirt, apply some neutral detergent diluted in 5 to 6 parts water to a soft cloth. Note that alcohol, thinner, benzene etc could cause damage to the paint or coatings.
5. Avoid making contact with the lens as damage may be caused.
6. If required clean the glass lens carefully using spectacle lens cleaning fluid on a soft cloth only.
7. The video recordings made by this Dash Cam are intended for personal use only.
8. Publication of the recordings on Youtube, the internet or other methods are subject to the Data Protection Act and the requirements thereof must be adhered to. If the Dash Cam is to be used within a commercial environment, i.e. truck use, then the CCTV regulation apply also, in addition to the Data Protection Act regulations. This includes labelling to identify the use of CCTV is taking place, the omission of Audio recording and informing the relevant authorities of who controls the data.
9. Whilst driving, do not adjust the controls of your device as this is a distraction to driving.
10. You agree to use your Nextbase Dash Camera in compliance with all applicable laws, including local laws of the country or region in which you reside or in which you use your Nextbase Dash Camera. When you use your Nextbase Dash Camera, you do so at your own initiative and you are responsible for compliance with any applicable laws, including but not limited to applicable privacy and data collection laws, and laws prohibiting or restricting the placement of objects on the windshield of a motor vehicle.

IT IS THE USER'S RESPONSIBILITY TO MOUNT THE DEVICE IN COMPLIANCE WITH ALL APPLICABLE LAWS AND ORDINANCES.

Portable Multimedia Limited trading as Nextbase is not responsible if you access or use your Nextbase Dash Camera in any manner that violates applicable law.

Cautions on using this product

1. Ensure that the windscreen is free of dirt or grease before placing mount upon it.
2. Do not obscure the view of the road ahead or impede the deployment of any airbags in the event of an accident.
3. When not in use, please disconnect the car adaptor from both the 12/24Vdc outlet in your vehicle.
4. Only clean the device with a soft dry cloth, for tough dirt, apply some neutral detergent diluted in 5 to 6 parts water to a soft cloth.
Note that alcohol, thinner, benzene etc could cause damage to the paint or coatings.
5. Avoid making contact with the lens as damage may be caused.
6. If required clean the glass lens carefully using spectacle lens cleaning fluid on a soft cloth only.
7. The video recordings made by this Dash Cam are intended for personal use only.
8. Publication of the recordings on Youtube, the internet or other methods are subject to the Data Protection Act and the requirements thereof must be adhered to.
If the Dash Cam is to be used within a commercial environment, i.e. truck use, then the CCTV regulation apply also, in addition to the Data Protection Act regulations. This includes labelling to identify the use of CCTV is taking place, the omission of Audio recording and informing the relevant authorities of who controls the data.
9. Whilst driving, do not adjust the controls of your device as this is a distraction to driving.

Declaration of Conformity

Declaration of Conformity

**We, Portable Multimedia Limited.
Dorna House Two,
52 Guildford Road,
West End, Surrey.
GU24 9PW
United Kingdom**

Declare under sole responsibility that the products:-

Product Name: NEXTBASE In Car Cam
Model number: NBDVR380GW

To which this declaration relates, is in conformity with the following standards,

EN 55032:2015
EN 61000-3-2:2014
EN 61000-3-3:2013
EN 55024: 2010+A1: 2015
IEC 61000-4-2: 2008
IEC 61000-4-3: 2006+A1:2007+A2:2010
IEC 61000-4-4: 2012
IEC 61000-4-5: 2014
IEC 61000-4-6: 2013
IEC 61000-4-8: 2009
EN 301 489-1 V2.2.0: 2017-03
EN 301 489-17 V3.2.0:2017-03
EN 301 489-19 V2.1.0:2017-03
EN 300 328 V2.1.1: 2016-11
EN 62311:2008
EN 60950-1: 2006 + A11:2009+A1 2010+A12:2011+A2:2013
2011/65/EU (RoHS directive)
2012/19/EU (WEEE Directive)
EC 1907/2006 (REACH)

Supplementary information:

This product complies with the requirements above and carries the CE mark accordingly.

Caerphilly, United Kingdom
(Place of issue)

10th June 2018
(Date of issue)

Graham Lambert
(Name of authorised person)

C. K. Lambert

(Technical Director)
(Signature of authorised person)
Telephone +44 2920 866429

Declaration of Conformity

FCC Statement

This device complies with Part 15 of the FCC Rules. Operation is subject to the following two conditions: (1) this device may not cause harmful interference, and (2) this device must accept any interference received, including interference that may cause undesired operation.

This equipment has been tested and found to comply with the limits for a Class B digital device, pursuant to Part 15 of the FCC Rules. These limits are designed to provide reasonable protection against harmful interference in a residential installation. This equipment generates, uses and can radiate radio frequency energy and, if not installed and used in accordance with the instructions, may cause harmful interference to radio communications. However, there is no guarantee that interference will not occur in a particular installation. If this equipment does cause harmful interference to radio or television reception, which can be determined by turning the equipment off and on, the user is encouraged to try to correct the interference by one or more of the following measures:

- Reorient or relocate the receiving antenna.
- Increase the separation between the equipment and receiver.
- Connect the equipment to an outlet on a circuit different from that to which the receiver is connected.
- Consult the dealer or an experienced radio/TV technician for help.
- This appliance and its antenna must not be co-located or operated conjunction with any other antenna or transmitter.
- A minimum separation distance of 20cm must be maintained between the antenna and the person for this appliance to satisfy the RF exposure requirements.

FCC CAUTION:

Any changes or modifications to the equipment not expressly approved by the party responsible for compliance could void your authority to operate the equipment.

FCC - SUPPLIER'S DECLARATION OF CONFORMITY STATEMENT

SUPPLIER'S DECLARATION OF CONFORMITY

(47 CFR Section 2.906).

We; Tank Design

Hereby, Declare that the essential requirements set out in the 47 CFR Sections 2.906 of FCC, have been fully fulfilled on our product with indication below:

1. Applicant's Info

Company Name: Portable Multimedia Ltd
Mailing Address: Unit 2, Caerphilly Business Park, Van Road, Caerphilly. CF83 3ED. UK
Contact: Graham Lambert
Tel: +44 02920 866429
Email Address: Support@nextbase.co.uk

2. Product Info

Product Name: Dash Cam
Model No.: NBDVR380GW
Brand Name: Nextbase

3. Applied Standard

Standards
E-CFR Title 47 Part 15 Subpart B—Unintentional Radiators: 2017

Report No. WTS18S08120193W

4. Test Firm Used to Take Measurements:

Name: Waltek Services (Shenzhen) Co., Ltd.
Address: 1/F, Fukangtai Building, West Baima Rd Songgang Street, Baoan District, Shenzhen, Guangdong, People's Republic of China, 518105
Contact Name: Philo Zhong
Tel: +86 755 8355 1033 802
Email: CB@waltek.com.cn
Designation No.: CN1201
FRN: 0027148261

5. FCC Marking



6. Responsibilities and obligations

Strictly follow the FCC rules of 2.906, 2.908, 2.909.

7. Applicant's Authorization

Company Name: Portable Multimedia Ltd
Mailing Address: Unit 2, Caerphilly Business Park, Van Road, Caerphilly. CF83 3ED. UK
Contact Person: Graham Lambert
Signature: *G. K. Lambert*
Email Address: Support@nextbase.co.uk
Tel: +44 02920 866429
Date: 20th August 2018

8. Responsible party in US.

Company Name: Tank Design
Mailing Address: 158 Sidney Street, Cambridge, MA 02139, United States
Contact Person: Mr Scott Watts
Signature: *Scott Watts*
Email Address: SWatts@tankdesign.com
Tel: (617) 388-8380
Date: 20th August 2018

Product Specification

Model Number / Name	NBDVR380GW
Power Requirements	5V / 1.5A
Power Supply	12-24Vdc Car Power Cable (supplied) Fuse Type: 20mm / 1.5A Output: 5Vdc
Sensor Resolution	2.12M Pixel
Lens - Type / Angle / Aperture	6G / 140° / F1.8
Recording Resolution	1920 x 1080 @ 30fps
Card Reader	8 - 128GB MicroSD Card
SD Card (Recommended Type)	8 - 128GB MicroSD Card, Class 10 for best results use a Nextbase branded SD Card.
SD Card Recorded file Capacity	8GB MicroSD = 60 minutes 16GB MicroSD = 120 minutes 32GB MicroSD = 240 minutes 64GB MicroSD = 480 minutes 128GB MicroSD = 960 minutes
Recording Format	.MOV
Unit Dimensions (inc. mount)	W58mm x L98mm x H47mm
Unit Weight (inc. mount)	125g
Cam Viewer (min req.)	
Android	V5.1
iOS	10.3
Replay 3 (min req.)	
Windows	Windows7
Mac	10.7

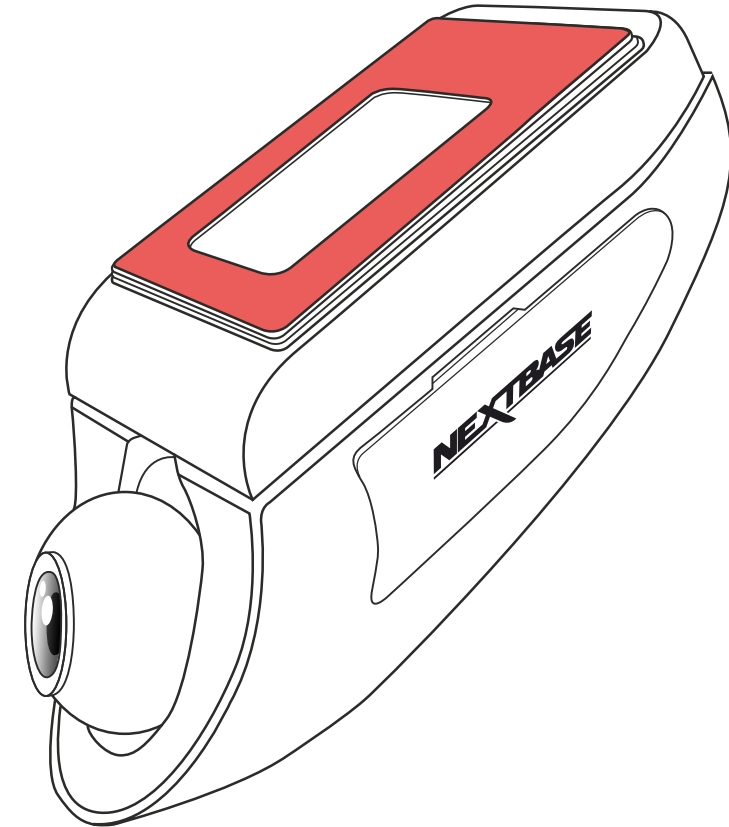

Android is a trademark of Google Inc. in the United States and other countries.

Mac is a registered trademarks of Apple Inc. in the United States and other countries.

iOS is a trademark or registered trademark of Cisco in the United States and other countries.

© 2015 Google Inc. All rights reserved. Google Maps™ mapping service is a trademark of Google Inc.

Windows is a registered trademark of Microsoft Corporation in the United States and other countries.

NEXTBASE Cam Viewer is a registered trademark of Portable Multimedia LTD in the United Kingdom.

microSD™ and the microSD logo are trademarks of SD-3C, LLC.

Wi-Fi® is a registered mark of Wi-Fi Alliance Corporation.

Other trademarks and trade names are those of their respective owners.

Package Contents

Please check the contents of your Nextbase product.

Dash Cam & Mount



Your Dash Cam to record the road ahead.

USB Cable

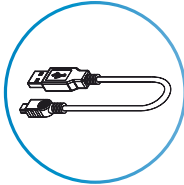

Connect your Dash Cam to your PC.

Security Pack

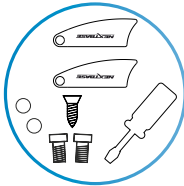

Use the additional security attachments to prevent tampering with the Dash Cam.

Quick Start Guide

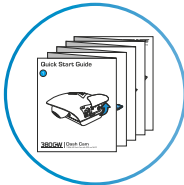

Quickly get your Dash Cam set up and running using the Quick Start Guide.

Window Stickers



Stickers for CCTV usage and to warn other road users that your vehicle is protected.

Manual, CCTV, & Software Disk



Everything you need to get you started with your Dash Cam.

Product Features

Thank you for purchasing this Nextbase Dash Cam, in this section we will outline some of the features available with this Dash Cam.

Designed in the UK the 380GW is discreet and fits neatly at the top of the windscreen to record the road ahead in FULL 1080p HD to ensure that you capture every detail such as road signs and number plates. The Nextbase 380GW Dash Cam has been made specifically for the commercial and fleet market, protecting both business and your drivers.

By having a unique lens with 90 degree vertical adjustment the Nextbase 380GW is the only Dash Cam really suited to commercial cars, vans and trucks with flat windscreens.

With any Dash Cam a key concern of any fleet manager is making sure that the device is running at all times. On the side of the Nextbase 380GW are special security covers, protecting the user controls to make sure the device is working. The SD card, power connector and On/Off button can all be locked away with security to ensure that the camera is running at all times and there is no chance of the SD card being tampered with.

1. Corporate responsibility – protect your employees and drivers on the road.
2. Prove that your driver wasn't to blame in the event of an incident.
3. In the event of an accident – Dash Cam footage can significantly reduce insurance claim time to get your fleet vehicles back on the road sooner.
4. Protect your brand reputation – by having a Dash Cam Drivers tend to be more cautious, on average 33% safer than without a Dash Cam*

*telematics scores with and without Dash Cam fitted

For Help and Support please call 02920 866 429

Powered GPS Mount

Please see below to identify the parts of the supplied GPS mount.

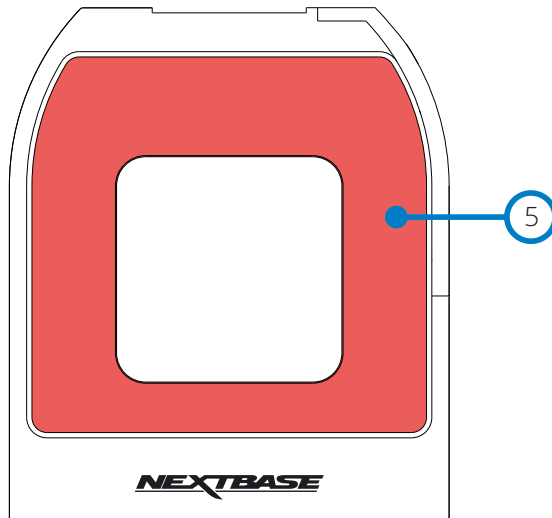
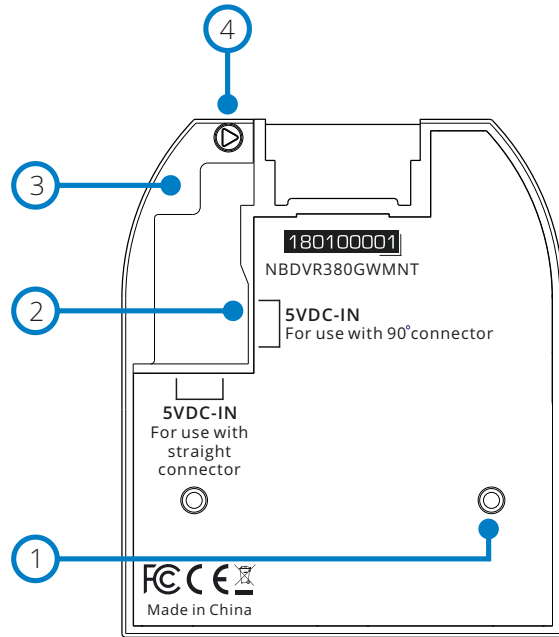

- 1 Locking Pins**
These pins will locate and then allow the camera to be attached to the mount.
- 2 DC-IN Sockets**
There are two sockets available, one for use with the supplied 90° car adaptor, the other for use with the Nextbase Hardwire Kit (sold separately) which uses a straight connector.

Please contact your Nextbase retailer to purchase the Nextbase Hardwire Kit.

- 3 Cable Lock**
The cable lock secures the car adaptor or hardwire kit cable to the mount.
- 4 Cable Lock Anti-Tamper Screw**
Location of the anti-tamper screw, that can be used to secure the cable lock to the mount. More information on the Anti-Tamper features of the 380GW can be found on page 25.
- 5 Adhesive Pad**
Once the backing tape has been removed this adhesive pad will securely adhere the mount to your windscreen.

Note:

- Before removing the red backing tape from the adhesive pad make sure you have determined the optimum position for the Dash Cam (see page 24) and that the windscreen is free of dust and/or dirt.
- A spare adhesive pad has been provided, in case you wish to change the mounts location.

Dash Cam - Parts and Controls

Please see below to identify the parts and controls of your Dash Cam.

Left side:

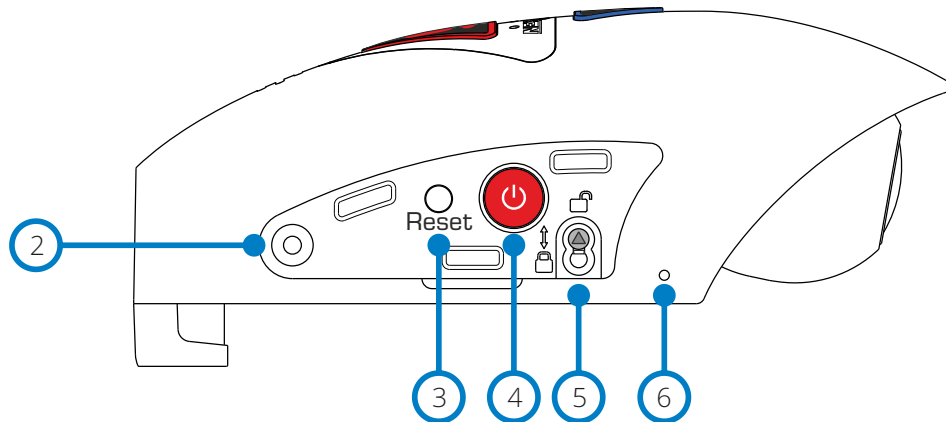
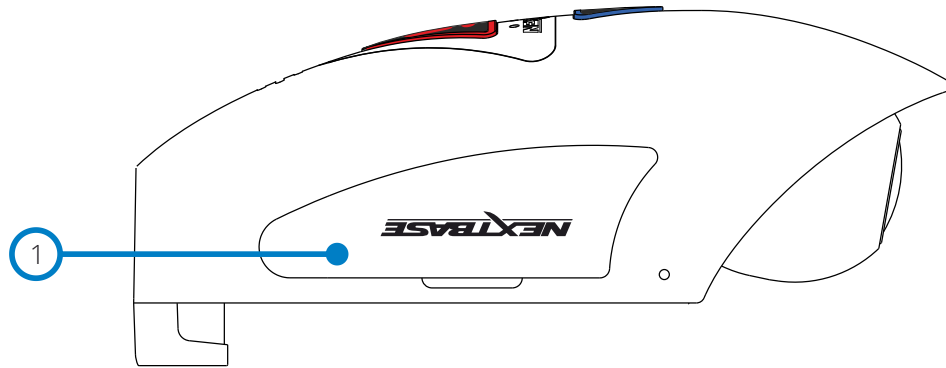

①

Side Cover

There are two types of side cover supplied:

Standard covers:

These are fitted when the Dash Cam as standard and are used during normal operation. Remember to replace the side cover before use.

Locking covers:

Included within the Security Pack are two locking covers, these can be secured to the Dash Cam using the supplied anti-tamper screws. This allows the owner of the vehicle to prevent un-authorized access to or operation of the Dash Cam.

②

Anti-Tamper Screw Insert

Insert thread for the anti-tamper screw.

③

Reset Button

In the unlikely event the Dash Cam becomes unresponsive, press the RESET button to restart the Dash Cam.

④

Power & Start / Stop Recording Button

Long press (2 seconds) power On/Off the Dash Cam.
Short press to start / stop recording.

⑤

Camera to Mount Locking Screw

The camera can be secured to the mount to prevent un-authorized removal, see page 25 for further details.

⑥

Microphone

Integral microphone for audio recording, this can be turned off via the Cam Viewer App.

Dash Cam - Parts and Controls (contd.)

Please see below to identify the parts and controls of your Dash Cam.

Right side:

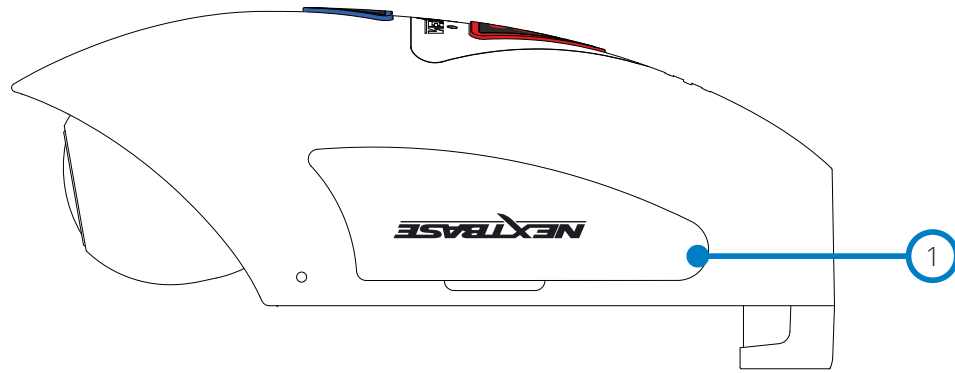

① Side Cover
Removable side cover, remember to replace the side cover before use.

② Anti-Tamper Screw Insert
Insert thread for the anti-tamper screw.

③ USB Socket
Connect the supplied USB data cable here to connect the Dash Cam to a computer.

Note:

During normal use the car power cable is connected to the mount, not directly to this socket.

④ SD Card Slot
Insert the MicroSD card here, taking care that the gold contacts are facing towards the mount.

⑤ Camera to Mount Locking Screw
The camera can be secured to the mount to prevent un-authorized removal, see page 25 for further details.

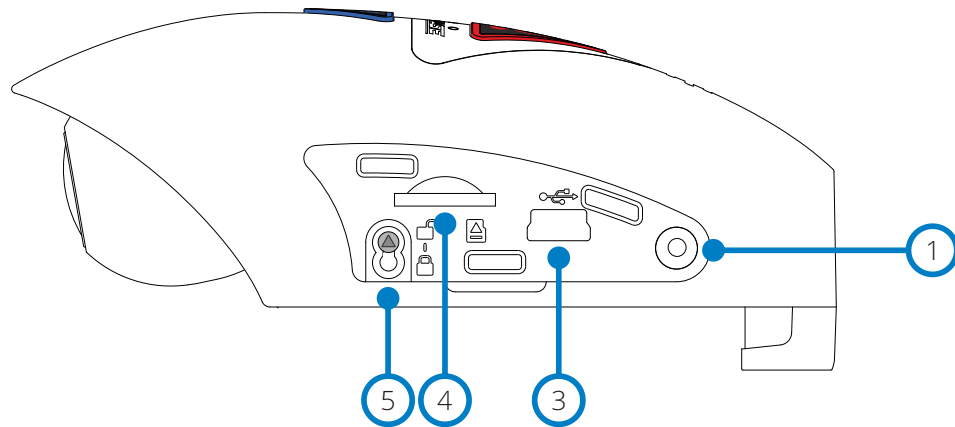

Dash Cam - Parts and Controls (contd.)

Please see below to identify the parts and controls of your Dash Cam.

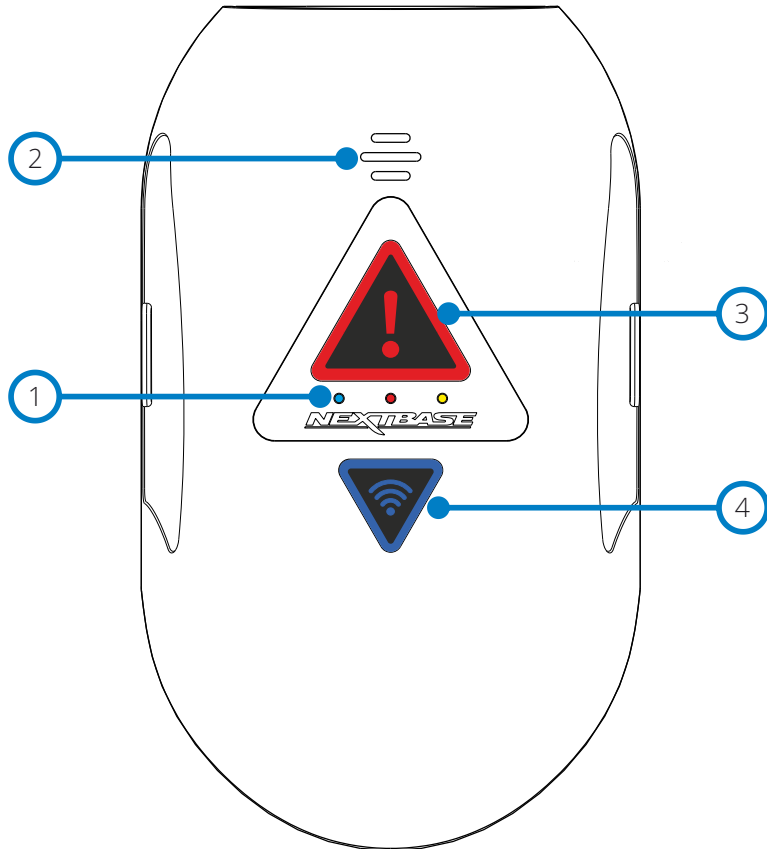

Top side:



1

LED Indicators

The functions of the three LED indicators are described in the below table.

LED Colour	Function	Slow Flash	Fast Flash	Solid
● Battery	Battery	-	Low Battery Warning	Battery Charging
● Power	Power	Recording	Updating FW	Power On
● GPS	GPS	Searching for GPS Lock	Formatting SD Card	GPS Locked
	Protect	Mass Storage Mode	Card Format/Bad Card	Protected
	Wi-Fi	Wi-Fi On/Update Mode	Card Format/Bad Card	Device Connected

Note:

- The blue LED will only function when there is a Nextbase 380 Battery Pack installed, this is sold separately. Please contact your Nextbase retailer to purchase the NBDVR380BAT.

- This Dash Cam uses Negative Temperature Coefficient (NTC) technology to protect the battery. This will shut down battery charging should the Dash Cam's internal temperature exceed 70 degrees.

Dash Cam - Parts and Controls (contd.)

2

Speaker

Used for the two types of 'notification' sounds.

Sounds:

There are two sounds, these are used to identify when recording starts and stops.

1. Start recording
A three-tone beep sound (ascending) will be heard when recording starts.
2. Stop recording
A three-tone beep sound (descending) will be heard when recording stops.

Announcements:

There are two spoken announcements, these are used to identify there is a SD card issue that needs attention before recording can start.

- i. Please insert Class 10 SD card
This is heard when there is either no SD card inserted, the inserted SD card is not of the Class 10 type or the SD card is defective and cannot be successfully formatted.
- ii. Card error, format SD card
The inserted card has previously been formatted to an incompatible standard for use with the Dash Cam, this is usually resolved by simply re-formatting the SD card within the Dash Cam.

See page 31 for details on how format the SD card.

Note:

- Should formatting the SD card not resolve the issue, please try another quality branded SD card, making sure that is a Class 10 (48MB/s minimum) type.
- The Sounds and Announcements can be turned On / Off from the Cam Viewer

3

Protect Button & Indicator

Press the protect button whilst recording to protect the current file, the button will illuminate, red in colour indicating the file is protected.

Depending on at which point during the current recording the file is protected, the camera will also save the previous or subsequent recordings, as follows:-

If the protection takes place during the first 3rd of the recording, the previous recording will also be protected.

If the protection takes place during the final 3rd of a recording, the next recording will also be protected.

Note:

- The protect button is also used when connecting the camera to a computer using the USB cable. Press and hold the protect button when connecting the camera to a computer and the Dash Cam will power on in Update Mode.

4

Wi-Fi Button & Indicator

Press and hold the Wi-Fi button for 2 seconds to turn on the Dash Cam's Wi-Fi function. Once turned on, the button will flash slowly blue in colour, awaiting a connection from a smartphone / tablet etc.

Once a device has been successfully connected the button will become solid blue. If no connection is established within 2 minutes, then the Wi-Fi function turns off automatically and the blue flashing light will extinguish.

See pages 27 - 32 for details on how to connect your mobile device to the Dash Cam and how to use the Cam Viewer App.

Note:

- The Protect button can also be used to format the SD card, when recording is stopped. Press and hold the Protect button for 6 seconds, the yellow LED will flash quickly during the SD card formatting process.

Dash Cam - Parts and Controls (contd.)

Please see below to identify the parts and controls of your Dash Cam.

Bottom:

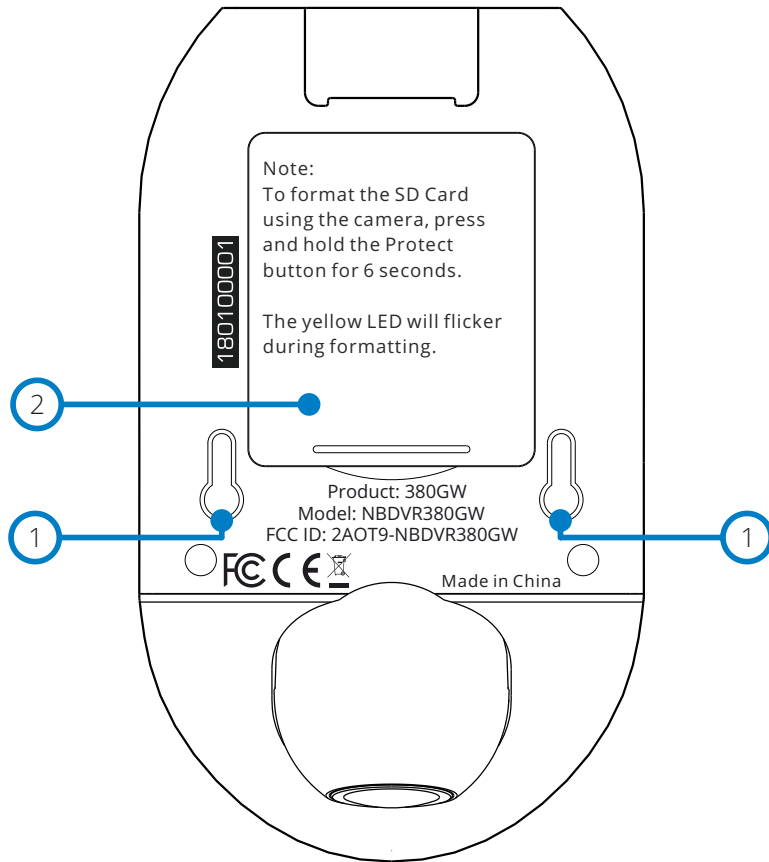

1 **Mount to Camera Fixing Points**
The mount locking pins locate here when attaching the camera to the mount.

2 **Battery Compartment**
For use with the battery pack (sold separately), required if using the Parking Mode function on a 'switched' live power source, i.e. a 12Vdc outlet that only provides power when the vehicles ignition is turned on.

Please contact your Nextbase retailer to purchase the battery, part number NBDVR380BAT.

Dash Cam - Parts and Controls (contd.)

Please see below to identify the parts and controls of your Dash Cam.

Front and Rear view:

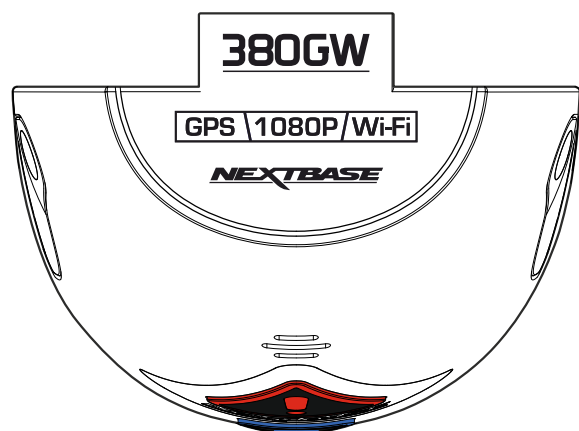
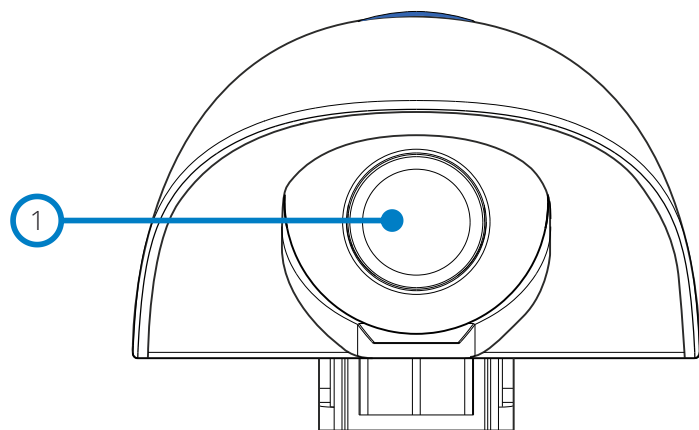

- ① Front Facing Camera Lens
Wide angle 140° field of view.

In Vehicle Installation

1

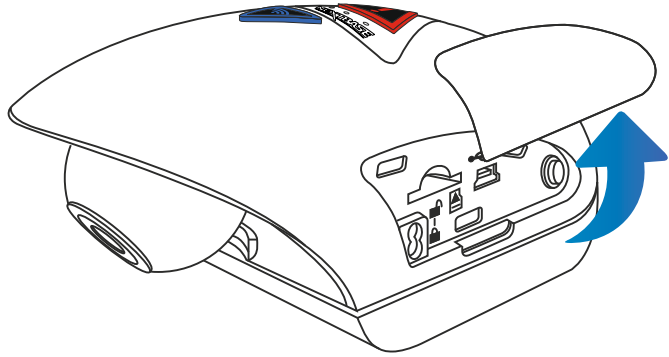

1 Remove Side Cover

Using the finger nail slot, remove the right hand side cover, under which the SD card slot is located.

2

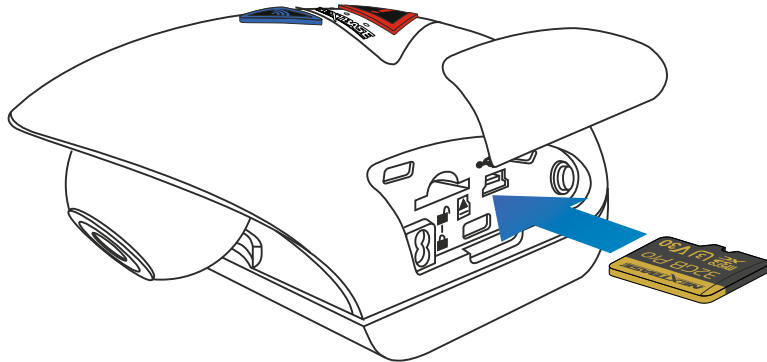

2 Insert micro SD Card

Insert the MicroSD card here, taking care that the gold contacts are facing towards the bottom of the Dash Cam.

3

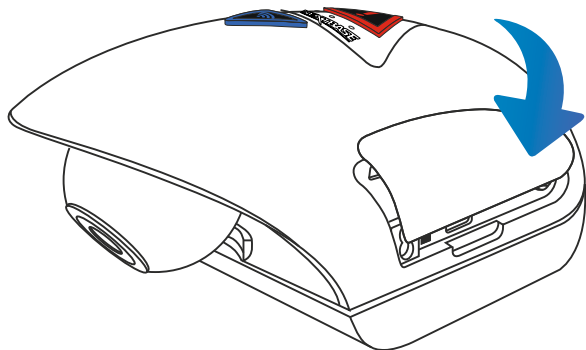

3 Replace Side Cover

Click the side cover back in to place, with the curved edge engaging firstly.

In Vehicle Installation (contd.)

4

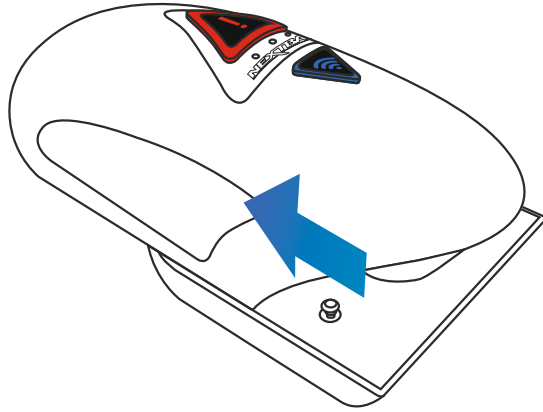

4 Remove Camera From Mount

Slide the mount towards the camera lens to disengage the mount.

5

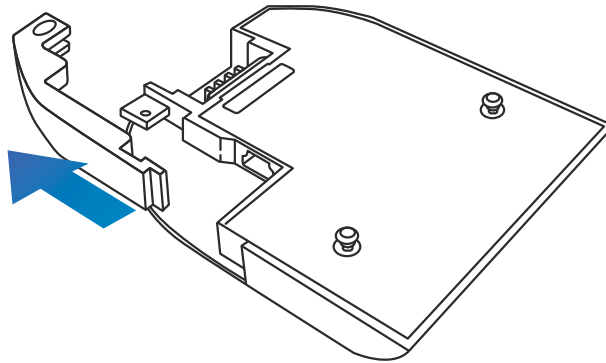

5 Remove Cable Lock

The cable lock is in the corner of the mount and can be twisted away from the mount itself and then disengaged completely from the mount.

6

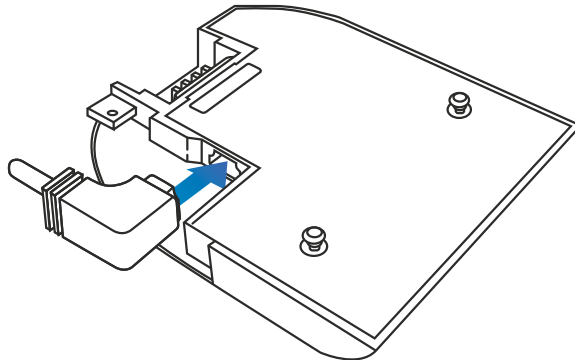

6 Connect Power

Connect the supplied Car Power cable in to the Mini USB socket marked 'For use with 90 connector'.

Note:

- The Nextbase hardwire kit connector will utilize the mini USB socket marked 'For use with straight connector'.
- Once the Car Power is connected to the Dash Cam mount, do NOT connect it to the 12-24Vdc power supply in your vehicle until the Rear Facing Camera has also been connected. ALWAYS make sure your Dash Cam is powered OFF before connecting or dis-connecting the Rear Facing Camera.

In Vehicle Installation (contd.)

7

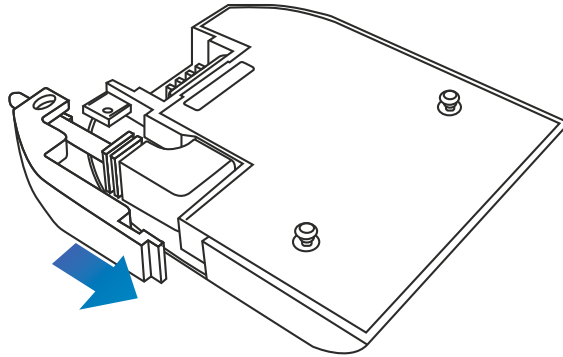

7 Refit Cable Lock

The cable lock can now be refitted by firstly inserting the tang fully and then rotating the cable lock until it engages fully around the power cable and then clicks in to place in the mount.

The cable clamp can be secured to the mount to prevent un-authorized removal, see pages 25 for further details on the 380GW's Anti-Tamper features.

8

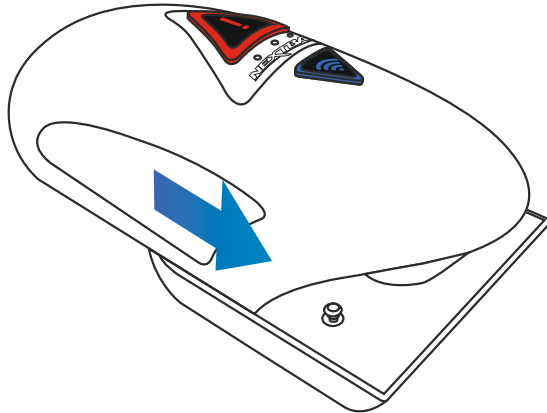

8 Refit Camera to Mount

Offer the mount to the camera to engage the locking pins and then slide the mount away from the camera lens to engage the mount connections fully.

Installing your Dash Cam

1

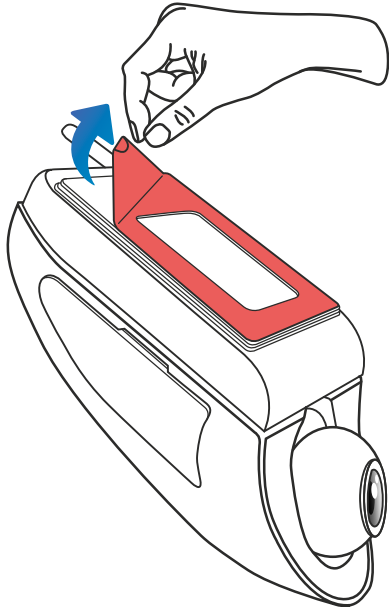

- 1 Remove the 3M protective sheet**
Peel off the red layer to expose the 3M sticky pad beneath.

2

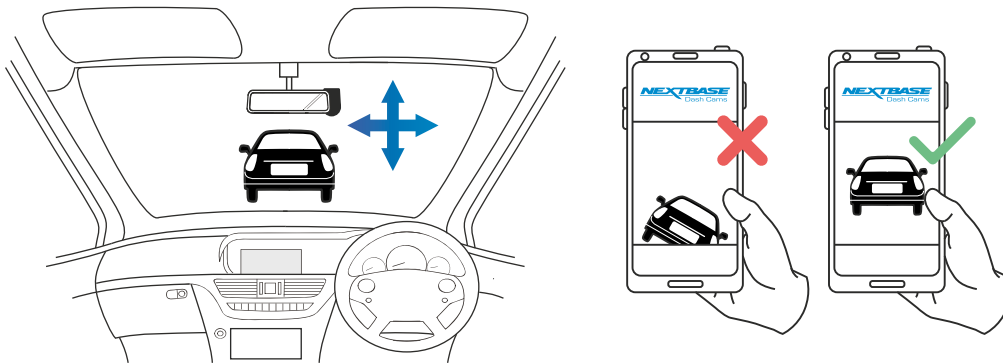

- 2 Locate and then check the 380GW camera position using App**
Offer the Dash Cam towards the windscreen whilst looking at the Live View on the connected smartphone / tablet. Ensure that the Live View shows the desired image by moving the Dash Cam to the best position possible on the windscreen and adjusting the lens accordingly.

Avoid any painted section of the windscreen being seen in the Live View and ensure the Dash Cam is mounted vertically, with the smartphone image the right way up ! For more information on where best to position your Dash Cam, see page 24 (Positioning your Dash Cam).

Installing your Dash Cam (contd.)

3

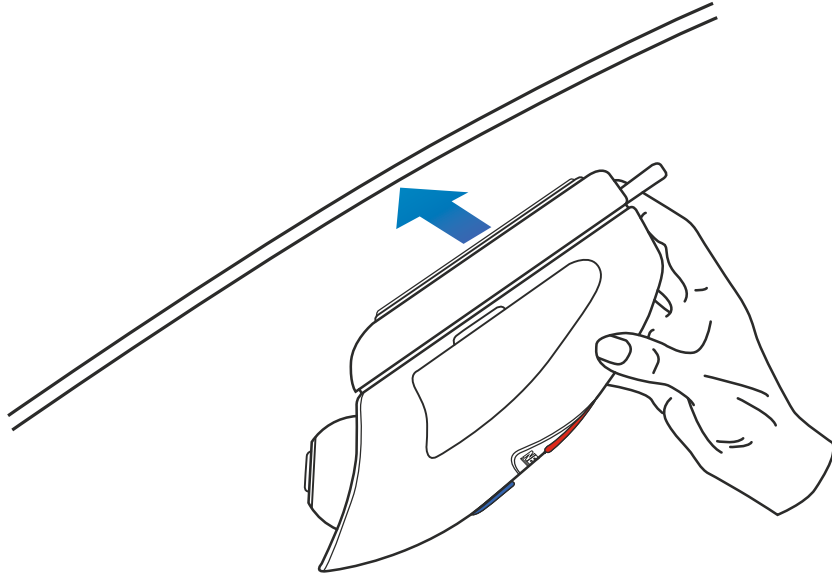

3 Apply mount to windscreen

Lightly press the mount against the windscreen and double check that the image as seen upon the smartphone / tablet is correct. Make any adjustments if required, prior to pressing the Dash Cam firmly against the windscreen to ensure that the 3M tape is securely attached.

4

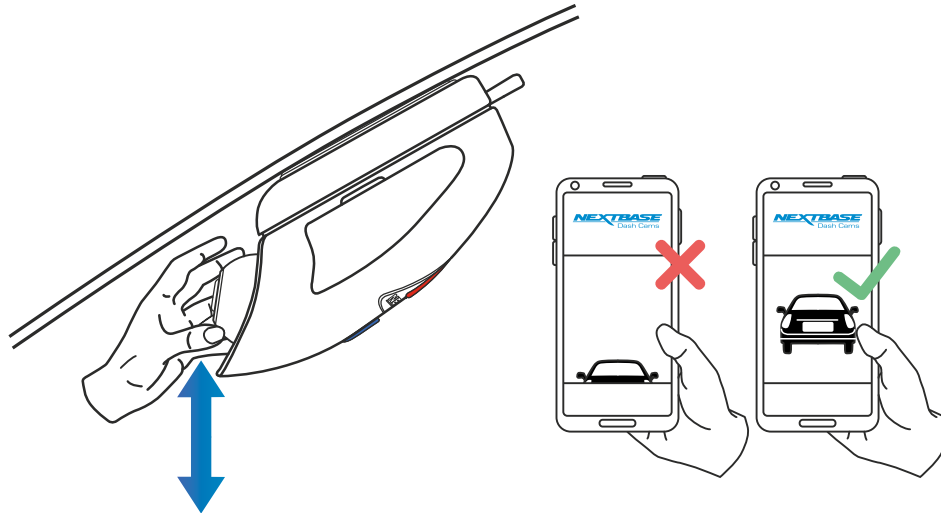

4 Adjust lens position as required

If any final adjustments to the lens position are required, then gently move the ball of the lens to the desired position using finger pressure, taking care not to touch the glass element of the lens itself.

Connecting your Dash Cam to the Cam Viewer App

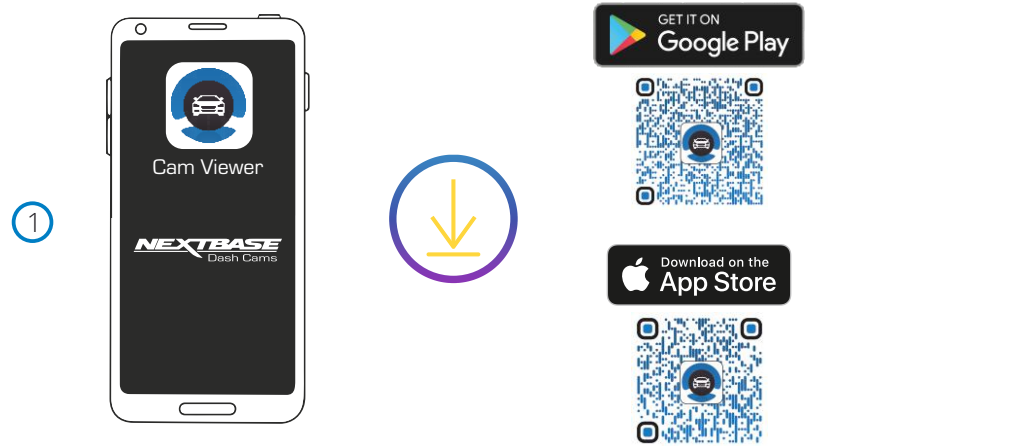

1 Download and Install the APP

Visit the appropriate APP store for your smartphone / tablet and download the Nextbase Cam Viewer APP.

Install the APP upon your device and then open the APP in readiness to connect to the Dash Cam.

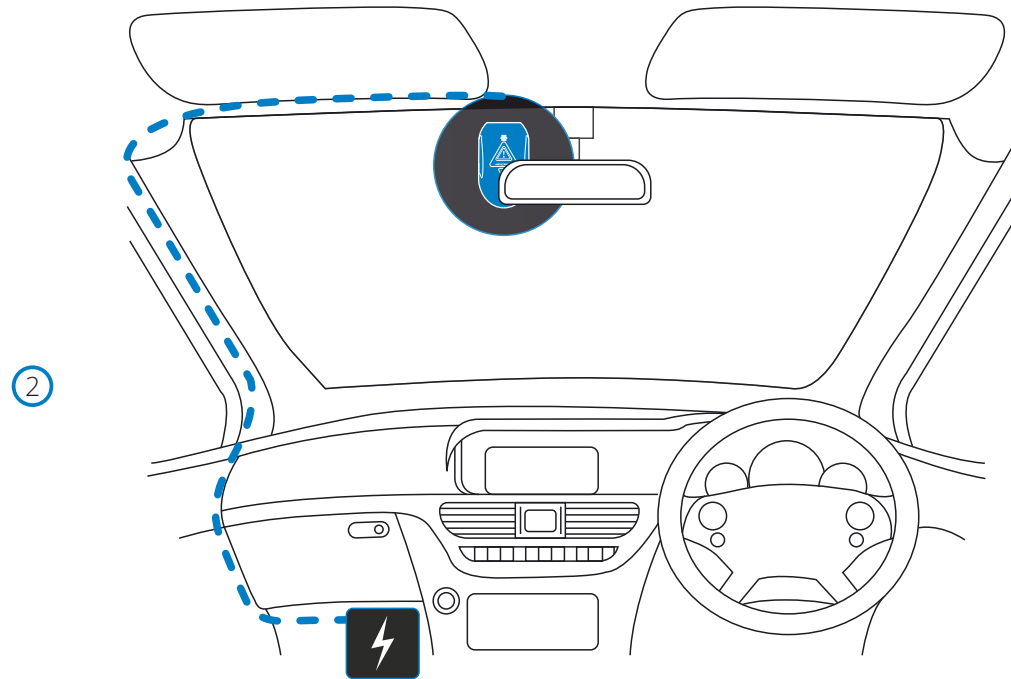

3 Route the supplied car power cable (as shown) and connect it to the DC-IN socket of the mount.

The Dash Cam will automatically power on and start recording once power is available. In some vehicles this will be when connections are made, for others the Dash Cam will power on once the ignition has been turned on.

If the vehicle in which the Dash Cam is installed has permanent live cigarette lighter sockets, the user can simply use the power button to switch the Dash Cam off when the vehicle stops. To take advantage of the Automatic Start / Stop Technology a Nextbase Hardwire Kit can be installed on a switched-live power supply.

The Nextbase Hardwire Kit includes the necessary 12-24Vdc to 5Vdc convertor and battery protection circuitry.

Should your vehicle not have a 12-24Vdc outlet, but does have a 5Vdc USB Outlet, this can be used instead. Connect the USB cable supplied with your Dash Cam in place of the car power cable.

You MUST however connect the USB cable to the mount, NOT directly to the Dash Cam USB socket.

Note:

- Do NOT wire the Dash Cam directly to a 12V supply by cutting the cigarette plug off the end of the cable, or damage will result.

Fuse Box

The above diagram is for illustration purposes only.

Connecting your Dash Cam to the Cam Viewer App (contd.)

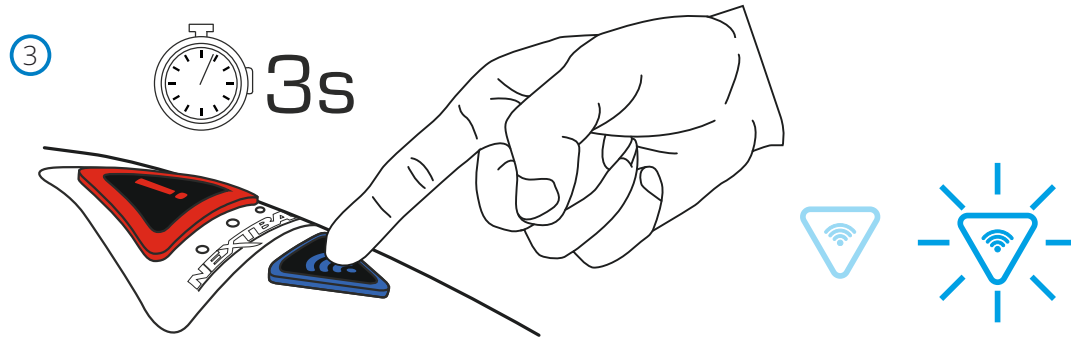

3 Turn On Wi-Fi Upon the 380GW

After the Dash Cam has powered on, then press the Wi-Fi button until the button starts to flash Blue in colour, to indicate that the Wi-Fi function is turned on and awaiting a connection.

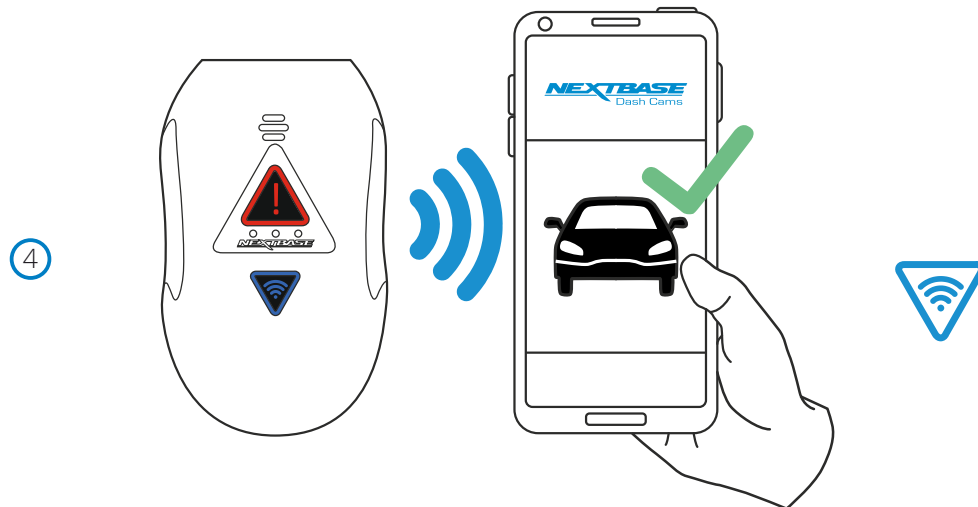

4 Connect Mobile Phone to the 380GW

With the Nextbase Cam Viewer APP working upon the smartphone / tablet, press "Connect to Dash Cam" and then choose the 380GW Dash Cam. When a connection is established, you will be notified on the Cam Viewer app, and the blue LED on the Dash Cam will now remain on. If the connection is lost or you disconnect your smartphone / tablet, the LED will turn off.

Positioning your Dash Cam

Please read and follow the notes below for the safe operation of your Dash Cam within your vehicle.

- As per the installation instructions, you must install the camera so it does NOT obstruct the drivers view of the road, preferably behind the rear view mirror.
- Whilst the camera clearly needs to view through the windscreen in an area swept by the windscreen wipers, the camera should be installed so as not to intrude significantly within the wiped area.
- A 40mm intrusion into the green wiped area is the maximum permitted by law.

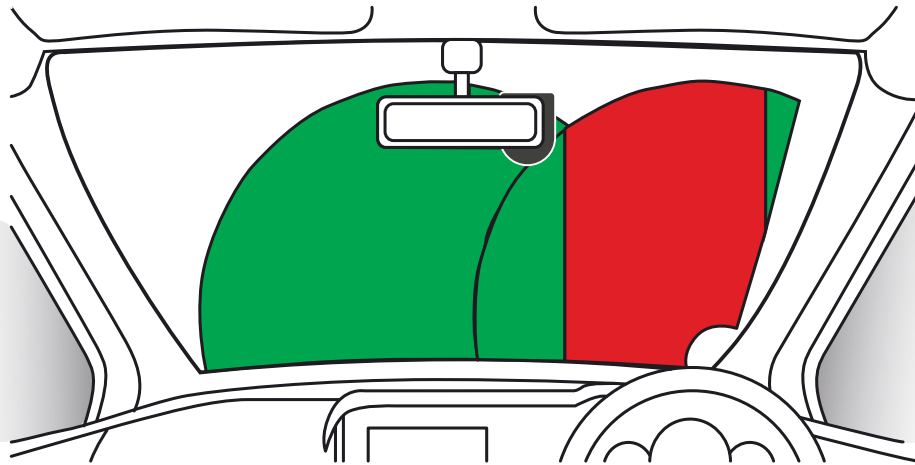

- Do NOT mount the Dash Cam in front of the driver directly, as depicted by the red area in the above illustration.
- When installing the Dash Cam in a vehicle, always place the device securely against the windscreen and where possible conceal the power cable under trim. Make sure that the Dash Cam power cable does not interfere with the drivers operating controls, such as the steering wheel, pedals or gear levers.
- Do NOT mount the Dash Cam in front of an airbag field of deployment or in a position to obscure any mirrors.
- Clean the windscreen at the point of location, prior to fitting the Dash Cam, to ensure absolute adhesion.
- It is recommended NOT to operate the Dash Cam whilst driving.
- The automatic Start-Stop technology incorporated within the device negates any need to operate the controls whilst driving.

Note:

- Adjust any settings or review recordings using the Cam Viewer APP, whilst stationary, not whilst driving.
- Only use your smartphone / tablet whilst stationary, not whilst driving.

For Help and Support please call 02920 866 429

Anti-Tamper Security Installation

This allows the Dash Cam to be setup for 'Authorised use only', therefore preventing un-authorized operation, or removal of the camera. Three elements of anti-tamper security are available, which can be used individually or all together, as required.

This is a three stage process, using the supplied Security Pack:

2x Locking covers



2x Anti-tamper screws (machined screws for use with the locking covers)



1x Anti-tamper screw (self-tapping screw for use with cable lock)



2x Dust caps



Security screwdriver

1 Cable Lock

The cable lock can be secured to the mount. This prevents the car adaptor or hardwire kit power plug from being disconnected from the mount and hence stopping the recording.

Once the car adaptor or hardwire kit have been connected to the mount and the cable lock has been located correctly, use 1x anti-tamper screw (self-tapping screw) to secure the cable lock to the mount. Tighten the screw until the head is flush with the top surface and do NOT over-tighten.

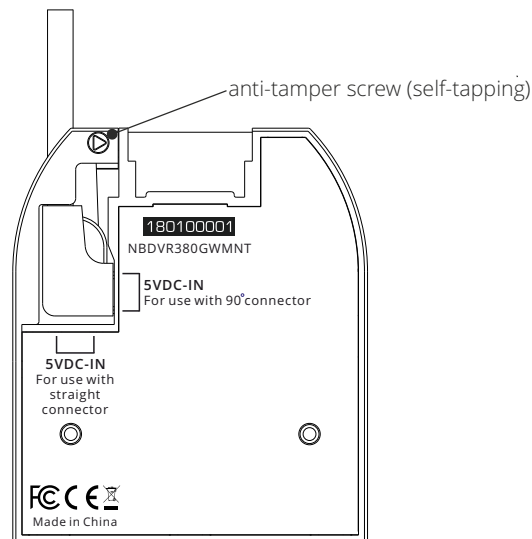

2 Camera to Mount Locking Screw

The camera can be secured to the mount to prevent un-authorized removal.

Remove the two side covers to gain access to the 'camera to mount' locking screws, these are found on both sides of the camera.

With the camera attached to the mount and using the supplied security screwdriver, loosen the two anti-tamper screws, taking care NOT to remove them fully.

Slide the anti-tamper screws down into the 'locked' position and then re-tighten.

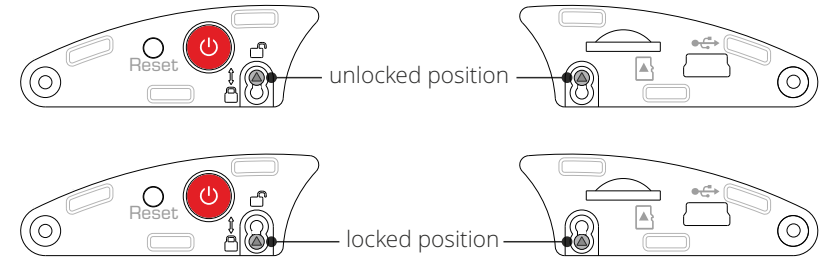

3 Locking Covers

Replace the normal side covers with the two locking covers and secure them to the camera using the anti-tamper screws (machined screws).

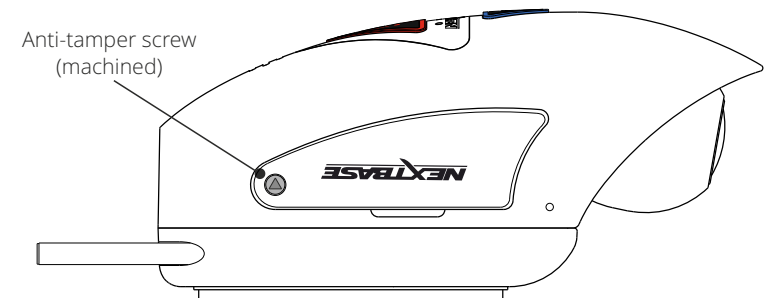

Carefully insert the supplied rubber dust caps, covering the heads of the anti-tamper screws.

Note

- To prevent un-authorized user's from accessing the camera via the Cam Viewer App, remember to change the Wi-Fi Password within the Setup menu.



Cam Viewer - Introduction

Nextbase Cam Viewer is a an APP specifically designed for use with the Nextbase range of Dash Cams and works with Android & iOS for use on Smartphones and tablets alike.

See Product Specification section for minimum Operating System requirements.

The APP allows you to watch the live view from your Dash Cam, make recordings, watch previous recordings and then download selected recordings accordingly. The recordings can then be used as evidence for any situation / incident or accident witnessed and can be shared accordingly.

The APP also allows you to make any changes required to the settings within the Dash Cam.

Nextbase Cam Viewer APP is available freely to Download from your applicable APP store, as shown below:-

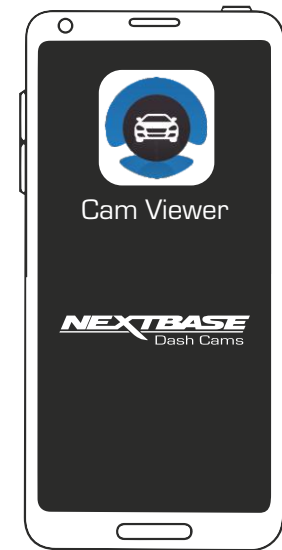

Please download, install and then run the APP, before continuing further with these instructions.

For Help and Support please call 02920 866 429

Cam Viewer - Connect your Device

Once you have downloaded Nextbase Cam Viewer for your mobile device, you will need to turn on the Wi-Fi function on your Dash Cam.

With the dash Cam powered on, press and hold the  button until it starts to flash blue. The flashing indicates that the Wi-Fi function is turned on and awaiting a connection.

The Dash Cam will appear as NEXTBASE 380GWA xxx, within the available networks seen on your mobile device.

When you launch Nextbase Cam Viewer you will see the Welcome Screen as shown below:-

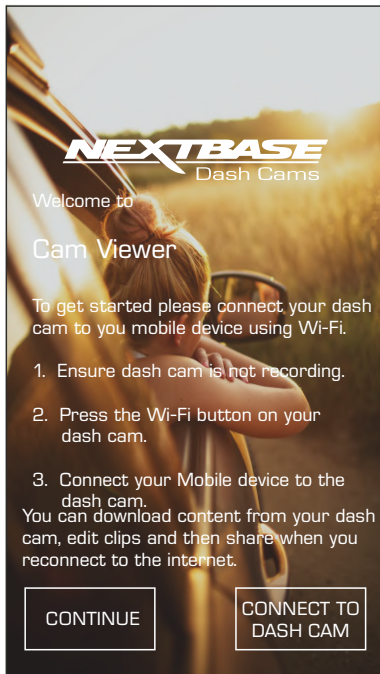

Tap the CONNECT TO DASH CAM Button and Nextbase Cam Viewer will then open your Settings screen for your mobile device.

Connecting to the Dash Cam is the same process as you would use to connect your mobile device to any Wi-Fi 'network'.

Select 'NEXTBASE 380GW xxx' from within the list of available networks and if prompted enter the default password '12345678'.

Cam Viewer - Main Screen

Once your mobile device is connected Cam Viewer will display the Main screen and you will see a live image from your Dash Cam as shown below:-

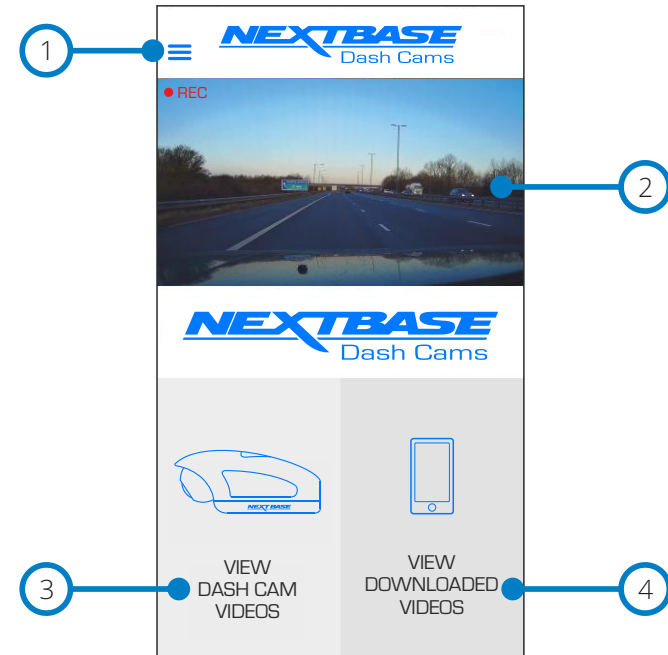

From within the Main screen you can select Live View, view recordings stored on your Dash Cam or recordings that have previously been downloaded to your mobile device. You can also access the Nextbase Cam Viewer Menu options.

- 1 Menu**
Tap here to access the Nextbase Cam Viewer Menu options, these include Dash Cam Settings.
- 2 Live View**
This window displays a live image from your Dash Cam. Tapping the Live View window will display the Live View full screen and allow you to stop and start recording.
- 3 View Dash Cam Videos**
Tap here to view videos that are stored on your Dash Cam. You can then stream the videos directly from your Dash Cam or download them to your mobile device.
- 4 View Downloaded Videos**
Tap here to view videos that have been downloaded from your Dash Cam to your mobile device. You can then play the files on your mobile device or share them online

Cam Viewer - Downloading Recordings

Downloading Videos from your Dash Cam (iOS)

To download files from your Dash Cam to your mobile device first tap on the View Dash Cam Videos button on the Main screen.

Nextbase Cam Viewer will then display a list of videos stored on your Dash Cam as shown below:-

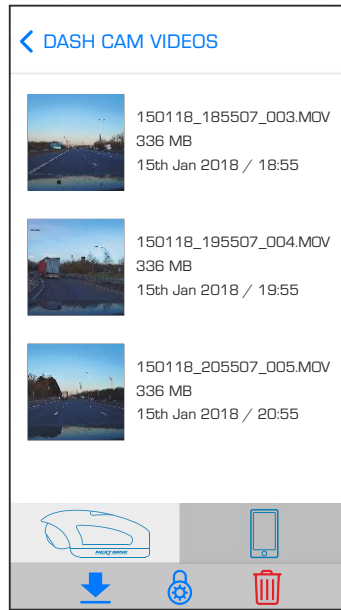

There are three buttons located at the bottom of the screen:-

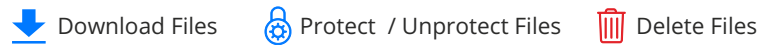

Tap the download files button and check boxes will appear next to each video, tap the videos that you wish to download and a tick will appear next to each selected video. You can tap a video a second time to deselect it.

When you have selected all of the files that you wish to download tap the Done button in the top right corner of the screen.

When you tap the Done button Nextbase Cam Viewer will display the progress of your video downloads on screen, you can tap the progress indicator at any time to cancel the current downloads.

Once videos have finished downloading they will appear in the Downloaded Videos screen which can be accessed from the Main Screen

Downloading Videos from your Dash Cam (Android)

To download files from your Dash Cam to your mobile device first tap on the View Dash Cam Videos button on the Main screen.

Nextbase Cam Viewer will then display a list of videos stored on your Dash Cam as shown below:-



Tap and hold on one of the videos that you wish to download and check boxes will appear.

Tap the videos that you wish to download and a tick will appear next to each selected video. You can tap a video a second time to deselect it.

Three buttons will also have appeared at the top of the screen.

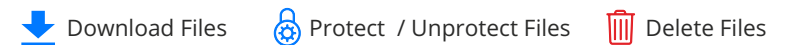

When all of the videos that you wish to download are selected tap the Download Videos button. When you tap the Download Videos button Nextbase Cam Viewer will display the progress of your video downloads

You can tap the Cancel button on the progress indicator at any time to cancel the current downloads.

Once videos have finished downloading they will appear in the Downloaded Videos screen which can be accessed from the Main Screen.

Cam Viewer - Sharing Recordings

Sharing Recordings

Once you have downloaded videos from your Dash Cam to your mobile device it is then possible to Share your videos online. In order to do this you will need to disconnect your mobile device from your Dash Cam Wi-Fi connection and connect to your usual Wi-Fi connection with internet access.

You should then tap on the View Downloaded Videos button on the Nextbase Cam Viewer Main screen.

The Downloaded Videos screen shows all videos that you have downloaded from your Dash Cam and functions in the same way as View Dash Cam Videos screen, however the Download button is replaced with a Share button, see below:-

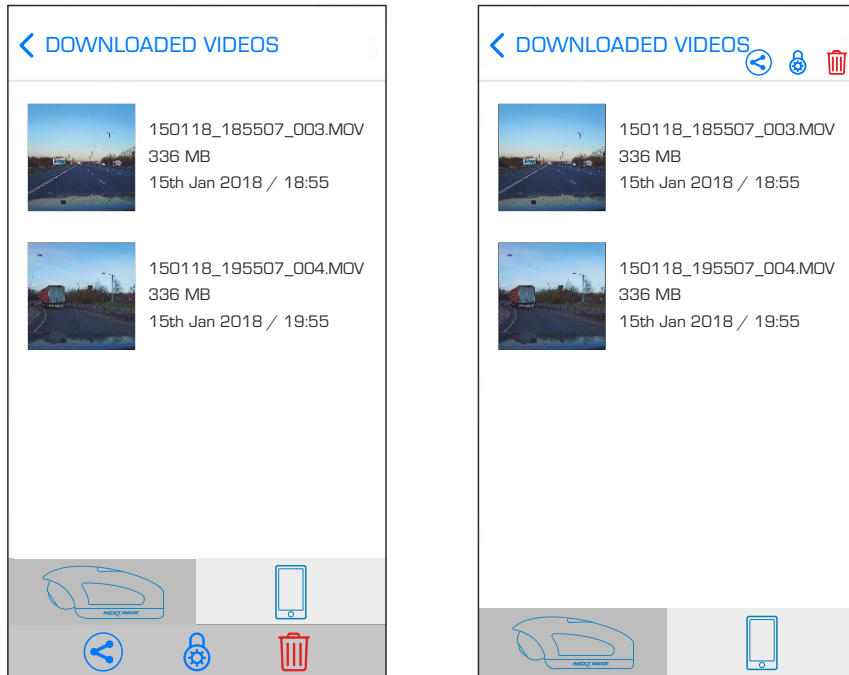

Tapping the Share button when files are selected will display the sharing options available on your device. This will include social media applications if installed on your device such as Facebook, YouTube or Twitter as well as the option to use Nextbase Private Share. Nextbase Private Share will allow you to upload your videos to the Nextbase Servers and when upload is completed you will be given a link which you can then send to friends or your insurance company allowing them to watch your video online.

Note

- The link will expire after 30 days and the video will be deleted from the Nextbase Servers.

Cam Viewer - Dash Cam Settings

The Dash Cam settings are accessed via the Cam Viewer App, tap the '☰' button to open the menu.

From the menu select 'Dash Cam Settings'.

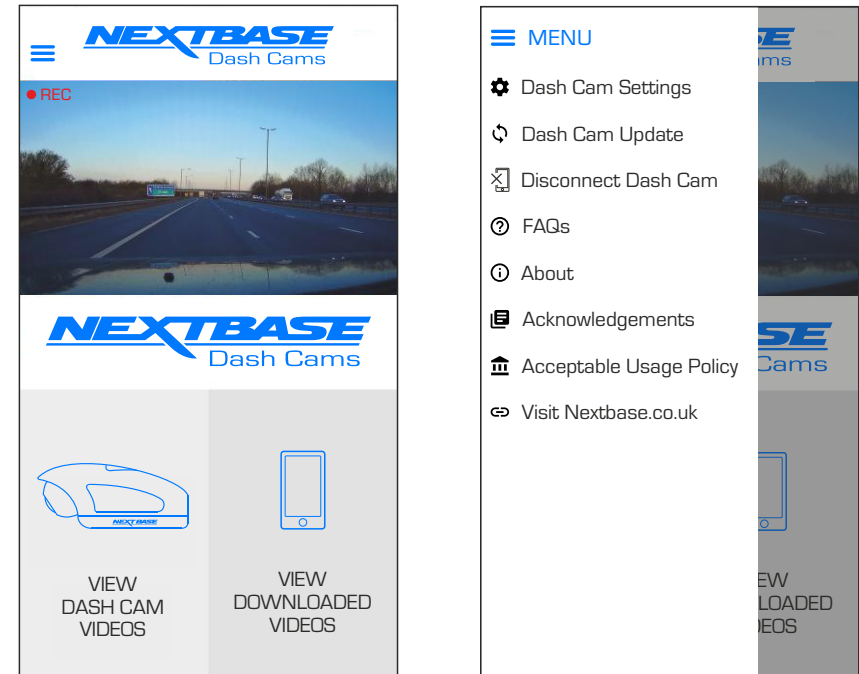

See following pages for full details of the various settings available.

Note

- Some settings may not be available depending on which iOS / Android version your mobile device is using.

Cam Viewer - Dash Cam Settings (contd.)

Video Menu

The default settings have been carefully selected to allow you to use the Dash Cam without the need to change any settings. However, should you wish to change a setting then please see below.

Note:

- Menus are not accessible whilst the Dash Cam is recording.

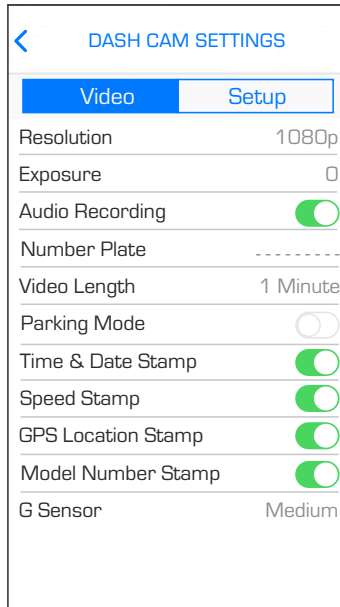

1 Resolution

Select recording resolution. With the Rear Cam connected, the Rear Cam's resolution will be set to that of the Dash Cam, and cannot be changed independently.

Options: 1080p and 720p
Default Setting: 1080p

2 Exposure

Adjust exposure level for different light conditions.

Options: +2, +1, 0, -1 and -2
Default Setting: 0

3 Audio Recording

Turn On / Off the microphone.

Options: On and Off
Default Setting: On

4 Number Plate

Enter the registration number for your vehicle, this will then be shown on the video file.

5 Video Length

Select the duration of the individual recorded video files. The Dash Cam will continue recording, filling the memory card. When the memory card becomes full, the oldest file will be automatically deleted to make space for the new recording.

Options: 1 Minute, 2 Minutes and 3 Minutes
Default Setting: 1 Minute

6 Parking Mode

There are two methods of using parking Mode, which one used is dependent on whether you are using a 'Permanent Live' or 'Switched Live'.

Permanent live:

This means that there is always 12Vdc being supplied to the Dash Cam. This can either be using a 12Vdc outlet that does not power off when the vehicles ignition is turned off or by using the Nextbase Hardwire Kit which has been installed using a permanent live fuse location.

Once Parking Mode has been turned on, the Dash Cam will enter standby mode when there is no physical movement detected for a 5 minute period.

Switched live:

This method requires the Nextbase 380 battery pack to provide power to the Dash Cam, as when the vehicles ignition is turned off the 12Vdc outlet will no longer supply power to the Dash Cam.

Note:

- Without the 380 battery pack installed Parking Mode will NOT function upon a switched live power supply.

When Parking Mode has been turned on, the Dash Cam enters standby mode when the 12Vdc supply has been turned off. Once activated Parking Mode functions in the same way for both Switched and Permanent power supplies:-

Should physical movement of the vehicle be detected, the Dash Cam will power on and start recording a 1 minute protected video. If no further physical movement is detected then the Dash Cam will return to standby mode. If physical movement is detected, then the camera will continue to record normally, until no physical movement detected for a 5 minute period, at which point the Dash Cam will return to standby mode.

Please note there will be a delay between the trigger even and the start of the recording while the Dash Cam turns on. 

Cam Viewer - Dash Cam Settings (contd.)

7 Time & Date Stamp

Turn On / Off the time and date stamp shown on recorded files.

Options: Off and On
Default Setting: On

8 Speed Stamp

Turn On / Off the Speed Stamp shown on recorded files.

Options: On and Off
Default Setting: On

9 GPS Location Stamp

Turn On / Off the GPS co-ordinates that are shown on recorded files. When a recording is viewed using the supplied NEXTBASE Replay playback software the GPS co-ordinates remain available.

Options: On and Off
Default Setting: On

10 Model Number Stamp

Turn On / Off the Model Number shown in the bottom left corner of recorded files.

Options: On and Off
Default Setting: On

11 G Sensor

Turn off or adjust the sensitivity of the built in G Sensor. The G Sensor detects forces which will automatically protect the current recording in event of a collision.

Note:

- This does not affect Parking mode sensitivity.

Options: High, Medium, Low and Off
Default Setting: Medium

Setup Menu

The default settings have been carefully selected to allow you to use the Dash Cam without the need to change any settings. However, should you wish to change a setting then please see below.

Note:

- Menus are not accessible whilst the Dash Cam is recording.

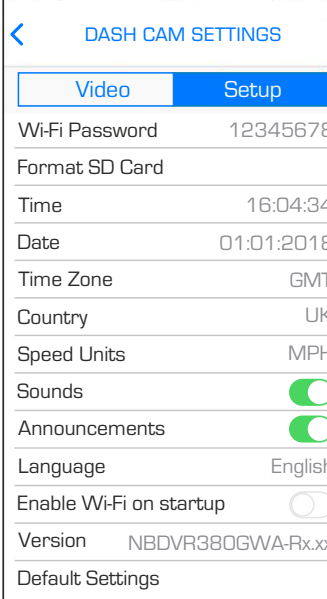

DASH CAM SETTINGS	
Video	Setup
Wi-Fi Password	12345678
Format SD Card	
Time	16:04:34
Date	01:01:2018
Time Zone	GMT
Country	UK
Speed Units	MPH
Sounds	<input checked="" type="checkbox"/>
Announcements	<input checked="" type="checkbox"/>
Language	English
Enable Wi-Fi on startup	<input type="checkbox"/>
Version	NBDVR380GWA-Rx.xx
Default Settings	

1 Wi-Fi Password

The Dash Cam's Wi-Fi password can be changed.

This is useful if you want to setup the Dash Cam for 'Authorised use only', therefore blocking unauthorised users from accessing the Dash Cam's functions and/or settings.

Default Setting: 12345678

2 Format SD Card

Format the inserted memory card. This will delete all content upon the SD card.

The SD card can also be formatted by pressing and holding the Protect button for 6 seconds, the yellow LED indicator will flash (quickly) during formatting.

Note:

- For stable performance, it is recommended that you format the memory card every 2 weeks. Of course, you should only do this AFTER you've downloaded any files from the card that you may want to keep.

Cam Viewer - Dash Cam Settings (contd.)

3 Time

This setting allows you to set the Time manually, if required during initial setup.

Note:

- The time will be overwritten when there is a subsequent satellite connection.

4 Date

This setting allows you to set the Date manually, if required during initial setup.

Note:

- The date will be overwritten when there is a subsequent satellite connection.

5 Time Zone

The Time and Date are automatically set from the satellite signal, but can be adjusted dependent upon your Time Zone or whether Daylight Savings Time is operational.

6 Country

Select your current Country, this will then automatically adjust the Time Zone / DST setting to your Time Zone, i.e. if France is selected the Time Zone will become GMT +1.

If your required Country is not available, select 'Other'. This will take you to the 'Time Zone' menu, from there you can manually select your Time Zone.

Options: United Kingdom, Belgium, Denmark, Finland, France, Germany, Italy, Netherlands, Norway, Poland, Spain, Sweden and Other
Default Setting: United Kingdom

7 Speed Units

Select whether to record and display speed in KMH or MPH.

Options: MPH and KMH
Default Setting: MPH

8 Sounds

Turn Off / On the device sounds, these will cancel the notification Sounds and also the Startup & Shutdown chimes.

Options: On and Off
Default Setting: On

9 Announcements

Turn Off / On the spoken announcements, these are heard when there is no SD card inserted or the SD card has an error and needs to be formatted using the Dash Cam.

Options: On and Off
Default Setting: On

Note:

- Announcements are currently only available in English.

10 Language

Select preferred language for the spoken announcements.

Options: English, Danish, German, Spanish, French, Italian, Dutch, Norwegian, Finnish and Swedish
Default Setting: English

11 Enable Wi-Fi on Startup

Once enabled the Dash Cam's Wi-Fi will turn on automatically when the Dash Cam starts up.

The Dash Cam's Wi-Fi will be seen as an Access Point (hotspot) by your mobile device, depending on the settings within your device it may automatically connect to the Dash Cam. This may leave you without a cellular connection.

Options: On and Off
Default Setting: Off

Note:

- Depending on your mobile device a Cellular connection may not be available during Wi-Fi connection to the Dash Cam, hence the recommended setting is off.

12 Version

The installed software version of your Dash Cam is displayed here.

13 Default Settings

Reset the Dash Cam to the default settings.

Nextbase™ SD Cards

For best results, we recommend using our Nextbase™ branded SD cards with your Dash Cam, available to purchase online from nextbase.com or your nearest retailer.

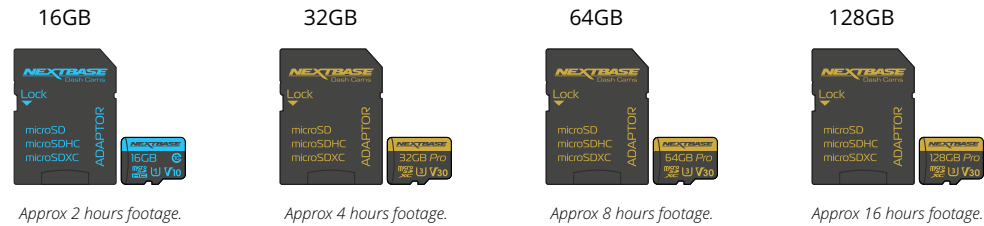

We recommend formatting your SD Card every 2 weeks to ensure that there is enough space to record and store new footage. When formatting, protected files WILL be deleted. If you wish to keep these protected files, you must back them up externally, most commonly by saving files to a desktop computer, or another secure storage point. To clear your SD card, go to the 'Format SD Card' function in your Dash Cam's Setup settings Menu and follow the instructions on screen.

Which SD Card should I use in a Dash Cam ?

Nextbase have designed an SD card specifically to fulfill the needs of our Dash Cams. We work directly with the factory to ensure consistency of the SD card quality. Nextbase have spent years testing, trialling, and developing SD cards to optimise their performance with our Dash Cams.

Due to the differences in technology an SD card that works with a mobile phone or computer won't necessarily work well with a Dash Cam. The main differences and selling points between all SD cards are the storage size (16GB, 32GB, 42GB, etc.) and the READ speed. READ speed isn't too important when it comes to Dash Cams, as a Dash Cam WRITES data to the SD card when recording. The ability to maintain a high WRITE speed consistently is what Nextbase SD cards are designed to do better than any other SD card. Any drop/fluctuation in WRITE speed within the SD card causes the Dash Cam footage to buffer, and in some cases will stop the recording entirely. Years of research and design allows our SD card controller and Firmware on the SD card to achieve the requirements of our Dash Cams, where other SD cards cannot.

A large requirement our Dash Cams place on the SD card is the ability to re-WRITE over the oldest footage when the SD memory becomes full. This means the Dash Cam is always Loop Recording - when the Dash Cam is on it is always recording. From our experience most non-Nextbase SD cards struggle to do this as effectively as our SD cards, this has caused footage to be missing and footage to fail to record in the first place.

SD Card Q&A

Q) "Why should I buy a Nextbase branded SD card? Can't I just use any card?"

A) Our cameras have different requirements to other recording devices; this is because they need to keep recording when the SD card is full whilst overwriting the oldest unprotected files at the same time.

Q) "Why are Nextbase SD cards more expensive than other brands SD cards?"

A) Years of research and development have led to the creation of an SD card that has superior capabilities to ensure it works with a Dash Cam, where other SD cards don't have such capabilities. Dash Cams have greater technological requirements from an SD card than a mobile phone or computer, for example, thus the larger price tag.

Q) "Do non-Nextbase SD cards work at all?"

A) A card that is not made for this purpose may appear to work perfectly in the beginning, although failure tends to happen after prolonged use, this could be days, weeks, or months. In a worst-case scenario, you may only discover recording failure after your SD card fails to record a serious incident, therefore using a suitable card is imperative.

Q) "What errors may I encounter using a faulty or incompatible SD card?"

A) You may experience any of the following:

- SD error messages
- Recording failure
- Automatic recording failure
- Frozen screen
- Gaps between recordings
- Corrupted or unplayable files
- Failure to startup and shutdown
- Inoperable buttons

If you experience any of the faults listed above, we strongly recommend that you replace your SD card with a Nextbase one. All our dashcams are tested using Nextbase branded SD cards, therefore we cannot attest to the compatibility of other manufactures products. For best results we always recommend using Nextbase branded cards.

Best practice is still to Format the SD card occasionally - for a heavy user this would be every two weeks, for a light user this would be once a month.



PC Connection

The dash cam has two available modes when connecting to a computer, these are:

Mass Storage Mode (Windows and Mac)

This mode is used to view, edit and share recordings using NEXTBASE Replay 3 playback software on your computer.

Note:

- Mass Storage mode is 'read-only', this means that content on the SD card can only be read, not updated or erased.

Update Mode (Windows and Mac)

This is used to Update the firmware on your Dash Cam, using NEXTBASE Replay 3.

Please see details within the NEXTBASE Replay 3 Playback software for more information.

Note:

- Update mode is 'read+write', this means that content on the SD card can be updated and erased. This in turn lets NEXTBASE Replay 3 write the new firmware to the SD card, allowing the automatic update to take place.

Connecting the Dash Cam to your Computer

The USB socket  is located on the left hand side of the Dash Cam, underneath the removable side cover. The side cover may or may not be screwed down, depending on how you have chosen to setup the Dash Cam.

Once the side cover has been removed, connect the supplied USB cable to the Dash Cam and then to your computer.

Do NOT connect the USB cable to the Powered Mount.

Once connected the Dash Cam will power on and automatically enter Mass Storage mode, this can be identified by the Protect Button flashing red.

To connect the Dash Cam in Update mode, press and hold the Protect button during connection of the USB cable. Release the button once the Wi-Fi button flashes blue.

Note:

- ALWAYS turn off the Dash Cam before disconnecting from your computer.



Trouble Shooting

Problem	Solution
The Mount will not stay in place.	Ensure that the red protective cover (plastic film) has been removed from the mount pad. Make sure that the glass is smooth and clean. Press the mount firmly to the glass ensuring that there is 100% contact with the glass. This can easily be seen from outside the windscreen, as contact area of the pad turns a darker colour. If the mount pad has lost it's sticky qualities, change the pad for the spare item contained within the box.
I cannot insert the MicroSD card.	MicroSD cards are very small and require delicate use. Align the card with the diagram shown upon the Dash Cam and insert the card until you feel a slight spring resistance. You now need to push the card, using your finger nail until you hear and feel a small click. Release pressure and the card will stay retained within the Dash Cam. If you are having difficulty, use the edge of a small coin.
I cannot remove the MicroSD card.	With the card installed, using your fingernail, you now need to push the card further inwards slightly, until you hear and feel a small click. If you are having difficulty, use the edge of a small coin. Release pressure and the MicroSD card will spring out far enough for you to take a hold of it.
I can only record a few minutes of video on my MicroSD card.	Replace the Class 10 type MicroSD card with a new quality branded card. Max 128GB. Ensure to format the new SD card from within the Dash Cam.
I cannot save files to the memory card when the Dash Cam is connected to my computer under 'Access Files'.	Correct, the Dash Cam is a 'read-only' device. It is not recommended to save files from other sources to the same memory that you will use for recording within the Dash Cam, as these may have a negative effect on the performance of the Dash Cam.
No power to my Dash Cam but it works upon my computer.	The cigarette power cable is not working. Inspect the fuse in the Car Power Cable plug. Replacement fuse = 2A 32mm type. If the fuse is found to be blown, inspect the power cable for damage which may have caused the fuse to blow.
My Dash Cam shuts down by itself after a while.	Either the battery has gone flat, there is no power to the Dash Cam and the Auto Power Off has been triggered, or Parking Mode has been turned on and no vehicle movement has been detected for 5 minutes.
The Battery will not charge.	Ensure that the 380 Battery Pack is in fact installed ! The battery pack is an accessory available separately. Ensure the Dash Cam is connected to a reliable power source and that the supplied Car Power Cable is being used, with the Power LED lit. The charging LED is blue and indicates whether the battery is being supplied with power, in order to charge.
The battery only lasts 30 seconds.	The battery will only receive charge when the Dash Cam is connected to power, please reconnect the car adaptor or domestic USB charger and leave the Dash Cam to charge. Charging takes approximately 90 minutes and a full charge is indicated when the BLUE (charging) LED goes out.
The battery on ly lasts 15 minutes.	This is normal, the battery is primarily for use with Parking Mode on a switched live power supply and NOT intended as an alternative power source to replace the supplied car adaptor.
I get the announcement "Card Error. Please format SD card".	The SD card has been formatted in another device and the Cluster Size is not compatible. There may also be an error on the card. Use the Setup option within the APP to re-format the SD card from in the Dash Cam. Ensure that the SD card is a Class10 type SD card of 8-128GB.
The SD Card in my Dash Cam cannot be read.	We recommend using a Nextbase branded SD card between 8GB and 128GB Class 10. Format the card from within the Setup Menu of the APP.
I can't delete files on my SD card within the Dash Cam.	Check to see if these files are 'protected', if so please follow instructions to 'un-protect' the files within the APP.
Mass Storage function does not work	The Mass storage function will work on both Windows and Mac. Restart the PC, as this may be required for the necessary driver to be loaded correctly. Disconnect and reconnect the Dash Cam. Contact NEXTBASE for the required driver.
Video Files cannot be played on my PC.	The video files from the Dash Cam are in .MOV format and may not be compatible with your PC if suitable playback software is not installed. Install the Nextbase Replay 3 playback software which is freely available from www.nextbase.co.uk
Video Image is blurred.	Remove the protective lens cover and check that the Dash Cam field of view does NOT include any painted section of the windscreen. Clean the lens, clean the windscreen!

Trouble Shooting

Problem	Solution
Video File playback is jumpy.	Reformat the SD card to remove non-contiguous files. For best recording use a quality branded Class 10 SD card of 8 to 128GB recommended size. PC may not be sufficient for the playback task, try a different PC. Copy the recorded video files onto the PC / Mac for playback directly rather than use the Dash Cam as a card reader. Reduce the resolution of the recording within the Dash Cam and record some new files to test if this is the problem.
The sound is not synchronised with video during playback.	The Codecs upon your PC may not be compatible or the latest standard. Download the latest Codecs from: www.nextbase.co.uk
Video has no sound.	Ensure that "Audio Recording" setting is turned ON within the Setup menu of the Dash Cam.
I have turned on 'Parking Mode' and now can't stop the recording.	The Dash Cam will start a recording whenever motion is detected. To turn off Parking Mode firstly shutdown the Dash Cam and remove the SD card, this will avoid recording being activated accidentally. Switch the Dash Cam On and connect to your mobile device using the Cam Viewer APP. Within the Dash Cam Setup Menu, turn off the 'Parking Mode'.
When I get in to my car, the Dash Cam is already recording and the file is protected.	This is normal. Parking Mode has been switched on and the Dash Cam has sensed vibration and has started to record correctly. Parking mode can be turned off within the Setup, Video menu if required.
The time on my Dash Cam is wrong and when I adjust the time manually, it keeps changing.	The Dash Cam sets the time based upon the country which has been selected and also whether Daylight Savings time is currently in force. Please verify the Country setting within the Cam Viewer APP Setup menu is correct. The Time Zone can be set manually, if the Dash Cam is to be used outside the listed countries.
Downloading files from www.nextbase.co.uk using Google Chrome results in a Malicious Software message.	This is not a cause for concern, simply go to the settings within Google Chrome and turn off the malicious software protection temporarily to download and install the playback software. Reinstate previous Google Chrome settings thereafter.
My Mobile Device will not connect to my Dash Cam.	Please ensure that you have turned the Dash Cam Wi-Fi Mode on by pressing the Wi-Fi button until it starts to flash. When Wi-Fi Mode is turned on the Blue Wi-Fi button will either flash when waiting for a connection, or be solid blue once connected to your mobile device.
The Nextbase Cam Viewer app will not open.	Please uninstall the NEXTBASE Cam Viewer app and re-download again from your devices App Store.
When I open the Nextbase Cam Viewer app I get a message saying "Please Check Device".	Ensure that the Dash Cam is in Wi-Fi Mode and that your mobile device has connected to the Dash Cam Wi-Fi network.
When I try to play back a file from my Dash Cam I get a message saying "Buffering" or a spinning circle, but the video does not load.	Please restart your mobile device and reconnect to the Dash Cam Wi-Fi network, then re-open the Cam Viewer App.
Video has no sound	Ensure that "Audio Recording" setting is turned ON within the Setup menu of the Dash Cam.
I have turned on 'Parking Mode' and now can't stop the recording.	The Dash Cam will start a recording whenever motion is detected. To turn off Parking Mode firstly shutdown the Dash Cam and remove the SD card, this will avoid recording being activated accidentally. Switch the Dash Cam On and connect to your mobile device using the Cam Viewer APP. Within the Dash Cam Setup Menu, turn off the 'Parking Mode'.
I have forgotten my password for the Wi-Fi connection	The password is a primary measure to ensure the privacy of your recordings and to prevent misuse of the Dash Cam. If the password has been changed from default and then forgotten, then the Dash Cam will need to have new firmware installed to reset the password (and all other settings) back to the defaults. Visit www.nextbase.co.uk for product firmware and instructions upon how to perform the update.
Unresolved Issues	Reset the Dash Cam to the Default Settings within the Setup Menu and try again. Should the problem persist call the helpline (02920) 866429 or e-mail: support@nextbase.com

CE Mark Information (Conformité Européenne)

The CE (Conformité Européenne) mark is a symbol (below) printed on products to indicate its conformity with health, safety, and environmental protection standards for products sold within Europe. It is used on many products across many industries (for example, SD cards) as a mark of compliance with European standards.



In recent years, many variations of this mark have appeared in the market. While similar, the mark above is the *only* variant that is associated with, and declares compliance with European standards. Other marks, like the ones below, do not guarantee that the product it is attached to or is compliant with European standards for sale in the European Economic Area (EEA).



The main difference between a legitimate CE mark and a misused CE mark is the spacing of the letters. The letters, C and E, tend to be formed identically, however the spacing between them is what separates the real from the false. The images below show how the letters should be spaced. There will never be additional markings such as a border or circle used on a legitimate CE Mark.

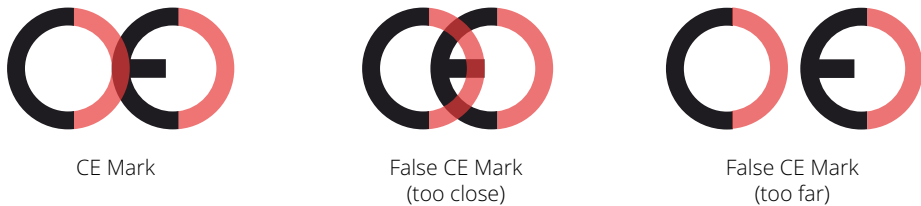

As products without the correct CE marking are not guaranteed to comply with European Health and Safety standards, those products are potentially less reliable and could pose a safety risk. Be aware of the CE marking when purchasing electrical products. The descriptions above of false CE markings are not comprehensive; be aware that new variations may appear on the market.

Software License Agreement

By using the device, you agree to be bound by the terms and conditions of the following software license agreement.

Nextbase™ grants to you for the period for which you possess the relevant device a non-exclusive, non-transferrable (save in circumstances where you sell or transfer the relevant device to another person – please see below for more details) a limited license to use the software embedded in this device (the “Software”) in binary executable form in the normal operation of the product together with any documentation and material (whether printed or on-line) made available by Nextbase™ in respect of the Software (the “Documentation”). Title, ownership rights, and intellectual property rights in and to the Software and the Documentation remain in Nextbase™ and/or its third-party providers.

You acknowledge that the Software and the documentation is the property of Nextbase™ and/or its third-party providers and is protected throughout the world by intellectual property rights laws and treaties, including the United States of America and international copyright treaties.

You further acknowledge that the structure, organization, and code of the Software, for which source code is not provided, are valuable trade secrets of Nextbase™ and/or its third-party providers and that the Software in source code form remains a valuable trade secret of Nextbase™ and/or its third-party providers. You agree not to decompile, disassemble, modify, reverse assemble, reverse engineer, or reduce to human readable form the Software or any part thereof or create any derivative works based on the Software or the Documentation.

You agree not to copy, rent, lease, sub-license, loan, translate, merge, adapt, vary, alter or modify, the whole or any part of the Software or Documentation nor permit the Software or any part of it to be combined with, or become incorporated in, any other programs

You agree not to export or re-export the Software or Documentation to any country in violation of the export control laws of the United States of America or the export control laws of any other applicable country.

If you use MyNextbase Connect™ or MyNextbase Player™, you must comply with the applicable terms of use and acceptable use policies, which can be found at www.Nextbase.com.

Warranty

Limited Warranty

This limited warranty gives you specific legal rights, and you may have other legal rights, which vary from state to state (or by country or province). Nextbase™ does not exclude, limit or suspend other legal rights you may have under the laws of your state (or country or province). For a full understanding of your rights you should consult the laws of your state, country or province.

Nextbase™ Liability extends to the cost of the Dash Cam alone. Any recordings which have not taken place or recoverable from the SD card for whatever reason are not covered by the product warranty. No liability for costs incurred due to corrupt, missing, erased video recordings will be accepted. No claims for additional costs outside the cost of the Dash Cam itself will be accepted.

Nextbase™ products are warranted to be free from defects in materials or workmanship for one year from the date of purchase, with batteries warranted to be free from defects in materials or workmanship for six months from the date of purchase. Within this period, Nextbase™ will, at its sole option, repair or replace any components that fail in normal use. Such repairs or replacement will be made at no charge to the customer for parts or labour, provided that the customer shall be responsible for any transportation cost. This Limited Warranty does not apply to: (i) cosmetic damage, such as scratches, nicks and dents; (ii) consumable parts, such as batteries, unless product damage has occurred due to a defect in materials or workmanship; (iii) damage caused by accident, abuse, misuse, water, flood, fire, or other acts of nature or external causes; (iv) damage caused by service performed by anyone who is not an authorised service provider of Nextbase™; (v) damage to a product that has been modified or altered without the written permission of Nextbase™, or (vi) damage to a product that has been connected to power and/or data cables that are not supplied by Nextbase™, or (vii) damage to a product that has been connected to 12Vdc directly, having cut off the Cigarette Lighter plug which contains the 12/24Vdc to 5Vdc adaptor. In addition, Nextbase™ reserves the right to refuse warranty claims against products or services that are obtained and/or used in contravention of the laws of any country.

To the maximum extent permitted by applicable law, the warranties and remedies contained in this limited warranty are exclusive and in lieu of, and Nextbase™ expressly disclaims, all other warranties and remedies, whether express, implied, statutory, or otherwise, including without limitation any implied warranty of merchantability or fitness for a particular purpose, statutory remedy or otherwise. This limited warranty gives you specific legal rights, and you may have other legal rights, which vary from state to state and from country to country. If implied warranties cannot be disclaimed under the laws of your state or country, then such warranties are limited in duration to the duration of this limited warranty. Some states (and countries and provinces) do not allow limitations on how long an implied warranty lasts, so the above limitation may not apply to you.

In no event shall Nextbase™ be liable in a claim for breach of warranty for any incidental, special, indirect or consequential damages, whether resulting from the use, misuse or inability to use this product or from defects in the product. Some states (and countries and provinces) do not allow the exclusion of incidental or consequential damages, so the above limitations may not apply to you.

If during the warranty period you submit a claim for warranty service in accordance with this Limited Warranty, then Nextbase™ will, at its option: (i) repair the device using new parts or previously used parts that satisfy Nextbase™'s quality standards, (ii) replace the device with a new device or a refurbished device that meets Nextbase™'s quality standards. Such remedy shall be your sole and

Warranty (cont.)

exclusive remedy for any breach of warranty. Repaired or replaced devices have a 30 day warranty. If the unit sent in is still under its original warranty, then the new warranty is 30 days or to the end of the original 1 year warranty, whichever is longer.

Before seeking warranty service, please access and review the online help resources available on www.nextbase.com. If your device is still not functioning properly after making use of these resources, contact a Nextbase™ Authorised service facility in the original country of purchase or follow the instructions on support at www.nextbase.com to obtain warranty service.

If you seek warranty service outside of the original country of purchase, Nextbase™ cannot guarantee that the parts and products needed to repair or replace your product will be available due to differences in product offerings and applicable standards, laws and regulations. In that case, Nextbase™ may, in its sole discretion and subject to applicable laws, repair or replace your product with comparable Nextbase™ products and parts, or require you to ship your product to a Nextbase™ Authorised service facility in the country of original purchase or to a Nextbase™ Authorised service facility in another country that can service your product, in which case you will be responsible for complying with all applicable import and export laws and regulations and for paying all custom duties, V.A.T., shipping fees and other associated taxes and charges. In some cases, Nextbase™ and its dealers may be unable to service your product in a country outside of the original country of purchase or return a repaired or replaced product to you in that country due to applicable standards, laws or regulations in that country.

Online Auction Purchases of Non-New Goods

Products purchased through online auctions are not eligible for Nextbase™ warranty coverage. Online auction confirmations are not accepted for warranty verification. To obtain warranty service, an original or copy of the sales receipt from the original retailer is required. Nextbase™ will not replace missing components from any package purchased through an online auction.

International Purchases

A separate warranty may be provided by international distributors for devices purchased outside the United Kingdom depending on the country. If applicable, this warranty is provided by the local in-country distributor and this distributor provides local service for your device. Distributor warranties are only valid in the area of intended distribution.



Dash Cams

Eyes on the Road

Nextbase™ offers a wide range of Dash Cams to best suit your driving needs.



122



222



322
GW



422
GW



522
GW

Rear View Cameras

Ready for the Drive

The new rear facing cameras offer views on the road behind as well as ahead, protecting you from all angles.



Accessories

Ready for the Drive

Everything you might need for video storage, Dash Cam protection, and more.



For more details on our full range of Dash Cams and Accessories, download the Nextbase™ Accessories Manual, available from www.nextbase.com

Nextbase™ Services and Software



MyNextbase.com Cloud™

Access your footage anywhere in the world using the free online web portal. (Internet connection required)



MyNextbase Connect™

The new Nextbase App to transfer, view, and edit footage on your smart-phone or tablet.



MyNextbase Player™

View, edit, and share your footage on your computer with the new easy to use free PC/Mac software.

Dash Cam Services Compatibility

	MyNextbase Cloud™	MyNextbase Connect™	MyNextbase Player™
122	✓	✗	✗
222	✓	✗	✓
322 GW	✓	✓	✓
422 GW	✓	✓	✓
522 GW	✓	✓	✓















122

222

322GW

422GW

522GW

	Main Resolution	720p @ 30fps	1080p @ 30fps	1080p @ 60fps	1440p @ 30 fps	1440p @ 30 fps
	Screen	2" LED HD IPS	2.5" LED HD IPS	2.5" LED HD IPS Touch	2.5" LED HD IPS Touch	3" LED HD IPS Touch
	Viewing Angle	120°	140°	140°	140°	140°
	GPS	No	No	10x GPS	10x GPS	10x GPS
	Wi-Fi	No	No	QuickLink Wi-Fi	QuickLink Wi-Fi	QuickLink Wi-Fi
	Bluetooth	No	No	4.2	4.2	4.2
	Polarising Filter	Compatible	Compatible	Compatible	Compatible	Yes
	Alexa	No	No	No	Alexa built-in	Alexa built-in
	Parking Mode	Intelligent	Intelligent	Intelligent	Intelligent	Intelligent
	Nextbase™ Emergency Response	No	No	Yes	Yes	Yes
	Nextbase™ Module Cam Compatible (Rear Cam, Rear Facing Cam)	No	No	Yes - Front 1080p Rear 720p	Yes - Front 1440p/1080p Rear 720p/1080p	Yes - Front 1440p/1080p Rear 720p/1080p
	Nextbase Cloud™ Storage	Yes	Yes	Yes	Yes	Yes
	MyNextbase Player™	No	Yes	Yes	Yes	Yes
	MyNextbase Connect™	No	No	Yes	Yes	Yes

NEXTBASE Dash Cams



www.nextbase.com



NBDVR380GW-IM-ENG-R9